

ThinkPad®

ThinkPad X1 Carbon Gen 13 User Guide



Lenovo

Read this first

Before using this documentation and the product it supports, ensure that you read and understand the following:

- *Safety and Warranty Guide*
- *Setup Guide*
- [Generic Safety and Compliance Notices](#)

First Edition (November 2024)

© Copyright Lenovo 2024.

LIMITED AND RESTRICTED RIGHTS NOTICE: If data or software is delivered pursuant to a General Services Administration "GSA" contract, use, reproduction, or disclosure is subject to restrictions set forth in Contract No. GS-35F-05925.

Contents

Discover your Lenovo notebook. v

Chapter 1. Meet your computer. 1

Front view	1
Side view	3
Bottom view	5
Features and specifications	6
USB specifications.	6

Chapter 2. Get started with your computer. 9

Set up your computer	9
Turn on the computer.	9
Complete the operating system setup	10
Access networks	10
Connect to Wi-Fi networks.	10
Connect to the wired Ethernet	10
Turn on Airplane mode	11
Manage power	11
Check the battery status	11
Charge the computer with ac power	11
Maximize the life of the battery	12
Charge your computer with P-to-P 2.0 charging function	12
Change the power settings	12
Interact with your computer	13
Use the keyboard shortcuts	13
Use the TrackPoint pointing device	14
Use the Haptic Touchpad (for selected models)	16
Use the Trackpad (for selected models).	17
Connect to an external display	20

Chapter 3. Explore your computer . . 23

Lenovo apps	23
Lenovo Commercial Vantage.	23
TrackPoint Quick Menu	23
Smart experiences.	25
Smart Modes	25
Smart Share	26
Smart Care	27
Copilot in Windows	27
Global Power Management	27
Cool and Quiet on Lap	28
Transfer data	29
Connect to a Bluetooth device	29

Chapter 4. Secure your computer and information 31

Lock the computer	31
Log in with fingerprint recognition	31
Log in with facial recognition.	32
Lock on leave function	32
Change the settings	33
UEFI BIOS passwords	33
Password types	33
Set, change, or remove a password	34
Associate your fingerprints with passwords	35
Protect data against power loss	36
USB-C Restricted Mode	36
FIDO (Fast Identity Online) authentication.	36
Register FIDO2 USB device in ThinkShield Passwordless Power-On Device Manager.	37
Log in to the System with Passwordless Power-On Authentication	37

Chapter 5. Configure advanced settings. 39

UEFI BIOS	39
Enter the UEFI BIOS menu.	39
Navigate the UEFI BIOS menu	39
Customize BIOS Defaults	39
ThinkShield secure wipe	40
Detect memory retraining	40

Chapter 6. Frequently asked questions. 41

Camera problems	41
Keyboard problems	41
What should I do if my keyboard is not working?.	41
Why is my keyboard backlight not working?	42
USB problems	43
Why is my USB connector not working?	43
How to recover data from a USB drive?.	43
How to create a recovery drive?.	44
Battery problems	44
What should I do if my computer battery is not recognized or the battery icon in the quick settings area disappeared?	44
What should I do if my computer battery is discharging quickly?	44
Fingerprint reader problems	45
What should I do when I cannot set up fingerprint recognition?	45

What should I do when there is an error during enrollment?	46
What should I do when fingerprint recognition always fails?	46
Mouse problems	47
Bluetooth connection problems	47
Wi-Fi connection problems	49
Pen problems	50
Startup problems	50
What should I do if my computer does not start up?	50
What should I do if I cannot log in to Windows?	51
What should I do if I encounter a blue screen during the startup?	51
Password problems	51
How to change my Windows password?	51
How to reset my Windows password?	51
How to find your BitLocker recovery key in Windows?	52
Performance problems	52
What should I do if my computer stops responding?	52
What should I do if my computer responds slowly?	53
Power charging problems	53
What should I do if my computer is connected to ac power but not charged?	53
What should I do if the built-in battery cannot be charged?	54
What should I do if the built-in battery is not fully charged?	54
Docking station problems	55
What should I do if the docking station has a poor connection?	55
What should I do if the docking station is well connected but does not work?	55
Hinge problems	55
Touchpad/trackpad problems	56
What should I do if my touchpad/trackpad is not responding?	56
What should I do if the touchpad/trackpad response is very slow?	56
Touch screen problems	56
Audio problems	57
Display problems	57
How to troubleshoot blue screen errors?	57
How to troubleshoot black screen issues?	58
How to troubleshoot screen flickering?	58
What should I do if the external monitor stops working?	59
What should I do if the display remains dim?	59
Fan problems	59

What should I do if the fan makes abnormal noise?	59
What should I do if my computer is overheating?	60
OS problems	60
How to install a Windows operating system?	60
How to upgrade a Windows operating system?	62
How to recover my Windows operating system?	63
Driver problems	64
UEFI BIOS problems	65
How to update the UEFI BIOS?	65
How to recover the UEFI BIOS?	66
How to reset system to factory defaults.	66
Copilot key problems	67
Self-help resources	67
Call Lenovo	69
Before you contact Lenovo	69
Find your service QR code and serial number	70
Lenovo Customer Support Center	70

Chapter 7. Diagnose and troubleshoot your computer. 73

Error messages	73
Battery-charge LED indicator diagnosis	73
Lenovo Memory Self Repair	75
Diagnostics tool.	76
Troubleshoot and diagnose at Lenovo Support Web site	76
Hardware scan	76
UEFI Diagnostics tool.	77
Windows label	77

Chapter 8. CRU replacement 79

CRU list	79
Before you replace any CRU	79
Disable Fast Startup	79
Disable the built-in battery	80
Replace a CRU	80
Base cover assembly	80
Built-in battery	81
M.2 solid-state drive and M.2 solid-state drive bracket	82

Appendix A. Compliance information. 85

Appendix B. Notice for USB connector name update 87

Appendix C. Accessibility features . . .	89	Appendix D. Notices and trademarks.	93
---	-----------	--	-----------

Discover your Lenovo notebook

Thank you for choosing a Lenovo® notebook! We are dedicated to delivering the best solution to you.

Before starting your tour, please read the following information:

- Illustrations in this documentation might look different from your product.
- Depending on the model, some optional accessories, features, software programs, and user interface instructions might not be applicable to your computer.
- Documentation content is subject to change without notice. To get the latest documentation, go to <https://pcsupport.lenovo.com>.

Chapter 1. Meet your computer

ThinkPad X1 Carbon Gen 13 provides you with unprecedentedly new experience of the computer.







Ultra smart: A Lenovo AURA EDITION product with a collection of premium, uncompromising, and exclusive experiences where endless possibilities meet ultimate personalization

Ultra light: Feather light and thin ever X1 Carbon

Front view

Have a quick glance at the front view of your computer.



Item	Description	Item	Description
	Microphone		Infrared camera
	Webcam privacy shutter		TrackPoint® pointing stick
	Fingerprint reader		Haptic Touchpad / Trackpad
	TrackPoint Three Buttons		

Note: Depending on the model, your computer comes with either a Trackpad or a Haptic Touchpad.

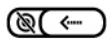

Webcam privacy shutter

Slide the webcam privacy shutter to cover or uncover the camera lens. It is designed to protect your privacy.





Related topics

- “Use the TrackPoint pointing device” on page 14
- “Use the Haptic Touchpad (for selected models)” on page 16
- “Use the Trackpad (for selected models)” on page 17
- “Log in with fingerprint recognition” on page 31
- “Log in with facial recognition (for selected models)” on page 32
- “Lock on leave function” on page 32

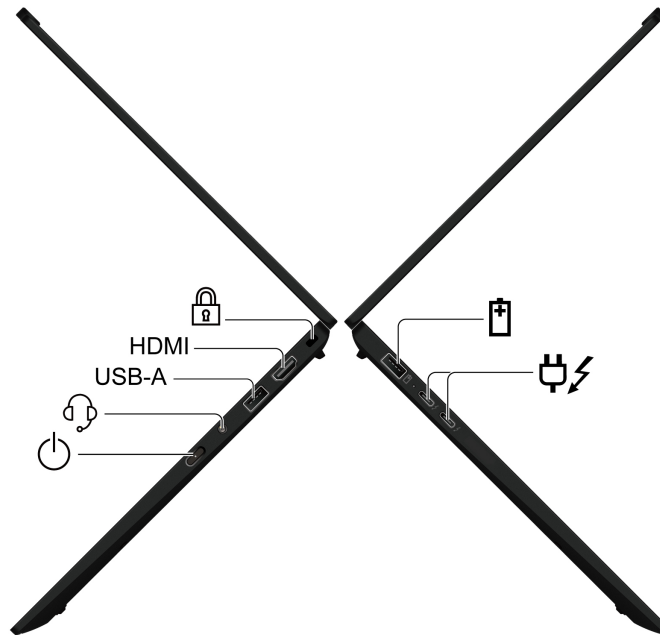
Side view

Have a quick glance at ports on both sides of your computer.



Item	Description	Item	Description
	USB-A connector (USB 5Gbps, Always On USB)		USB-C® power connector (Thunderbolt™ 4)
	Power button		Audio connector
USB-A	USB-A connector (USB 5Gbps)	HDMI	HDMI™ connector
	Security slot		

Note: For more information about the USB connector name update, see Appendix B “Notice for USB connector name update” on page 87.

Statement on USB transfer rate

Depending on many factors such as the processing capability of the host and peripheral devices, file attributes, and other factors related to system configuration and operating environments, the actual transfer rate using the various USB connectors on this device will vary and will be slower than the data rate listed in the connector name or below for each corresponding device.

USB device	Data rate (Gbps)
Thunderbolt 3	40
Thunderbolt 4	40

Related topics

- “USB specifications” on page 6
- “Manage power” on page 11
- “Connect to an external display” on page 20
- “Lock the computer” on page 31

Bottom view

Have a quick glance at the bottom part of your computer.



Emergency-reset hole

Emergency-reset hole can help you to recover computer when the computer stops responding and you cannot turn it off by pressing the power button. Do the following to reset your computer:

1. Disconnect your computer from ac power.
2. Insert a straightened paper clip into the hole to cut off power supply temporarily.
3. Connect your computer to ac power and then turn on your computer.

Note: If your computer is still no response, you can call Lenovo Customer Support Center to get further help.

CAUTION:

When the computer is operating, it should be placed on a hard and flat surface with its bottom area not in contact with user's bare skin. Under normal operating conditions, the temperature of the bottom surface will remain within an acceptable range as defined in IEC 62368-1, but such temperatures can still be high enough to cause discomfort or harm to the user if directly touched for over one minute at a time. As such, it is recommended that users avoid prolonged direct contact with the bottom of the computer.

Features and specifications

Get to know more hardware and software details of your computer.

Specification	Description
Memory	Low Power Double Data Rate 5X (LPDDR5X), soldered on board, up to 32 GB
Storage device	One slot, 2280 M.2 solid-state drive, up to 2 TB Note: In case of M.2 SSD replacement, your computer only supports single-sided M.2 SSD. Double-sided M.2 SSD is not applicable due to the height limitation of the slot.
Audio	<ul style="list-style-type: none">• Dolby Atmos®• Dolby Voice®
Display	<ul style="list-style-type: none">• 2.8K, 120 Hz refresh rate OLED display• Display ratio: 16:10• Display resolution: 2880 x 1800 pixels• TUV Eye Safe certified
Security features	<ul style="list-style-type: none">• Face authentication• Lock on leave• Fingerprint reader• Privacy Guard*• Privacy Alert*• Trusted Platform Module (TPM)*
Wireless features	<ul style="list-style-type: none">• Bluetooth• Wireless LAN

* for selected models

USB specifications

Get to know more USB specifications.

Notes:

- Depending on the model, some USB connectors might not be available on your computer.
- On very rare occasions, the USB-C compatible devices connected to the USB-C connector might interfere with the wireless features. If your computer cannot be connected to Wi-Fi or cellular network, detach the USB-C compatible devices from the USB-C connector.

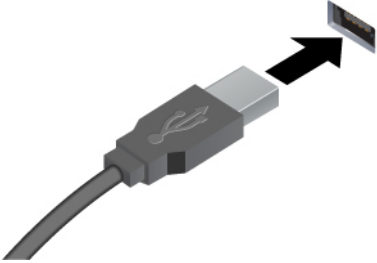
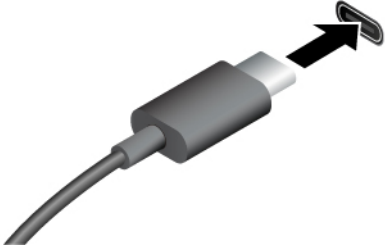
Connector name	Description
	<p>Connect USB-compatible devices, such as a USB keyboard, USB mouse, USB storage device, or USB printer.</p>
<ul style="list-style-type: none"> • USB-A connector (Hi-Speed USB) • USB-A connector (USB 5Gbps) • USB-A connector (USB 10Gbps) 	
	<ul style="list-style-type: none"> • Charge USB-C compatible devices with the output voltage and current of 5 V and 1.5 A. • Connect to an external display: <ul style="list-style-type: none"> – USB-C to VGA: up to 1920 x 1200 pixels, 60 Hz – USB-C to DP 1.4: up to 5120 x 3200 pixels, 60 Hz – USB-C to DP 2.1: up to 7680 x 4320pixels, 60 Hz • Connect to USB-C accessories to help expand your computer functionality. To purchase USB-C accessories, go to https://www.lenovo.com/accessories.
<ul style="list-style-type: none"> • USB-C connector (USB 5Gbps) • USB-C connector (USB 10Gbps) • USB-C connector (Thunderbolt 3) • USB-C connector (Thunderbolt 4) • USB-C connector (USB4 40Gbps) • USB-C connector (DP Alt mode DP 2.1) 	

Chapter 2. Get started with your computer

This chapter introduces the instructions of setting up your computer, various ways to connect to networks, and to interact with your computer.

Set up your computer

This section helps you to set up your computer and get it ready for use.

Turn on the computer

Follow the instructions to turn on your computer.

- Step 1. Connect the ac power cord to the ac power adapter.
- Step 2. Connect the dc cable to your computer.
- Step 3. Plug the ac power cord into the ac power.
- Step 4. Press the power button to turn on your computer.



Notes:

- The appearance varies depending on the computer model.
- Some models might not ship with ac adapters or power cords. Use only the certified adapters and power cords provided by Lenovo that comply with the requirements of relevant national standards to charge the product. It is recommended to use the Lenovo qualified adapters. You can refer to <https://www.lenovo.com/us/en/compliance/eu-doc>.
- It is recommended to fully charge the computer when using it for the first time. Click the battery status icon at the bottom right of your desktop to check the battery status.

Related topics

- “Check the battery status” on page 11
- “Charge the computer with ac power” on page 11

Complete the operating system setup

Before exploring your computer, you need to complete the operating system setup. The setup includes but is not limited to:

- Select the country or region.
- Connect to an available network.
- Accept the license agreement.
- Create a Microsoft account or log in with your Microsoft account.
- Set up your password, fingerprint, or facial recognition as preferred.
- Customize your experience.

Notes:

- Depending on the model, some settings might not be available on your computer.
- Do not turn off your computer and ensure it is connected to the ac power during the whole process.

Follow the instructions to set up the operating system.

Step 1. Connect the computer to the ac power and turn it on.

Step 2. Follow the on-screen instructions to complete the operating system setup.

Related topics

- “Log in with your fingerprint” on page 31
- “Log in with facial recognition” on page 32
- “Set, change, or remove a password” on page 34

Access networks

This section helps you connect to a wireless or wired network.

Connect to Wi-Fi networks

Click the network icon  on the bottom right of your display to connect to an available network. Provide required information, if needed.

Note: The wireless LAN module on your computer might support different standards. For some countries or regions, use of 802.11ax might be disabled according to local regulations.

Connect to the wired Ethernet

To connect your computer to a local network, you need a Lenovo USB-C to Ethernet Adapter. Lenovo USB-C to Ethernet Adapter is available as an option and shipped with some computer models. You can purchase one from Lenovo at <https://www.lenovo.com/accessories>.

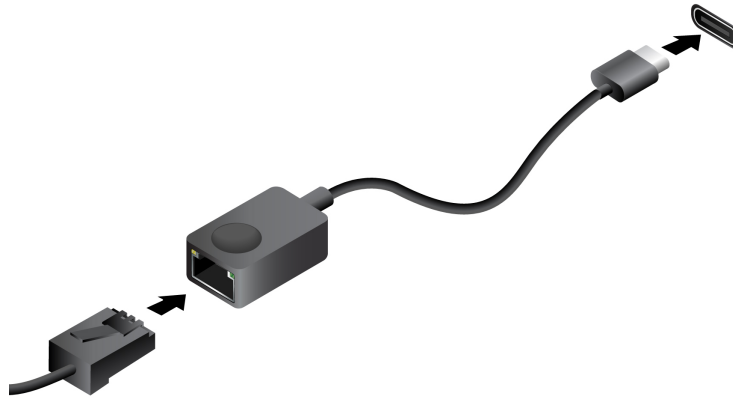

Turn on Airplane mode

You might need to turn on Airplane mode if you board an airplane. When Airplane mode is on, all wireless features are turned off automatically. Click the network icon  on the bottom right of your display to turn on Airplane mode.

Note: You can enable Wi-Fi networks in this mode according to your actual needs.

Manage power

Use the information in this section to achieve the best balance between performance and power efficiency.

Check the battery status

Check the battery status to help use computer properly.

Go to **Settings** → **System** to check the battery status. For more details about your battery, refer to the Vantage app.

Charge the computer with ac power

Power source of the ac power adapter:

- Power: 65 W
- Sine-wave input at 50 Hz to 60 Hz
- Input rating of the ac power adapter: 100 V to 240 V ac, 50 Hz to 60 Hz
- Output rating of the ac power adapter: 20 V dc, 3.25 A

When the battery power is low, charge your battery by connecting your computer to ac power with the supplied power adapter. The 65 W ac power adapter supports the rapid charge function, the battery is 80% charged in about one hour when the computer is turned off. The actual charging time depends on the battery size, the physical environment, and whether you are using the computer.

Battery charging is also affected by its temperature. The recommended temperature range for charging the battery is between 10°C (50°F) and 35°C (95°F).

Note: Some models might not ship with ac adapters or power cords. Use only the certified adapters and power cords provided by Lenovo that comply with the requirements of relevant national standards to charge

the product. It is recommended to use the Lenovo qualified adapters. You can refer to <https://www.lenovo.com/us/en/compliance/eu-doc>.

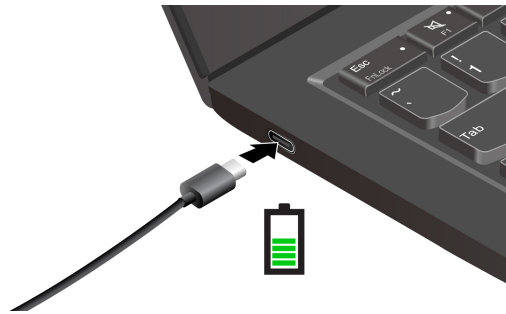

Maximize the life of the battery

Follow the instructions to maximize the life of the battery.

- Use the battery until the charge is depleted and recharge the battery completely before using it. Once the battery is fully charged, it must discharge to 94% or lower before it will be allowed to recharge again.
- Keep the battery from full charge when it is not in heavy use. For more information, refer to the **Battery settings** tab in the **Power** section of the Vantage app.
- The battery might optimize its full charge capacity based on your usage. After prolonged periods of limited use, full battery capacity might not be available until you discharge to as low as 20% and recharge completely. For more information, refer to the **Battery settings** tab in the **Power** section of the Vantage app.

Charge your computer with P-to-P 2.0 charging function

Both USB-C connectors (Thunderbolt 4) on the computer feature the Lenovo-unique P-to-P 2.0 (Peer to Peer 2.0) charging function.

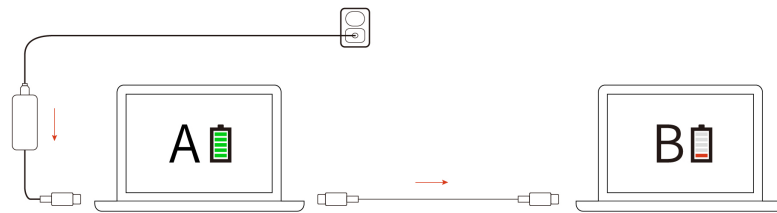

Note: The actual charging speed of your computer depends on many factors, such as the remaining battery power of the computers, the wattage of the ac power adapter, and whether you are using the computers.

To use the function, ensure that **Always On USB** and **Charge in Battery Mode** are enabled in UEFI BIOS of your computers, so that the function works even when the computers are off or in hibernation mode. To enable **Always On USB** and **Charge in Battery Mode**:

- Step 1. Restart the computer. When the logo screen is displayed, press F1 to enter to the UEFI BIOS menu.
- Step 2. Click **Config** → **USB**, and then to enable **Always On USB** and **Charge in Battery Mode**.

Change the power settings

Follow the instructions to change the power settings of your preference.

For ENERGY STAR® compliant computers, the following power plan takes effect by default when your computer is on ac power and has been idle for a specified duration:

- Turn off the display: After 5 minutes
- Put the computer to sleep: After 5 minutes

To change the power plan, the power button function and other settings, do the following:

Step 1. Go to **Control Panel** and view by Large icons or Small icons.

Step 2. Click **Power Options**.

Step 3. Change the settings as you prefer.

Interact with your computer











Explore various ways to interact with your computer.

Use the keyboard shortcuts



Keyboard shortcuts are keys or combinations of keys that provide a quick way to perform particular functions. They help you work more efficiently.

The following tables introduce the functions of keyboard shortcuts.

FnLock and function keys

Key / Key combination	Function description
	Switch between the special and standard functions of the function keys (F1–F12).
Fn+FnLock	Function keys provide two sets of functions: special function and standard function. Icons on the key denote the special function, such as  and  . Characters on the key denote the standard function, such as F1 and F2. LED indicator on Esc key indicates which function of the function keys is enabled: <ul style="list-style-type: none"> • When the indicator is off, the special function is enabled. • When the indicator is on, the standard function is enabled.
	Mute / Unmute (Speakers).
	Decrease volume.
	Increase volume.
	Enable / Disable the microphone.
	Decrease screen brightness.
	Increase screen brightness.
	Select and set up display devices.
Mode	Launch and hide the Smart Modes widget.
PrtSc	Print screen.
	Open Snipping Tool.
	Launch the Smart Connect feature in the Intel® Unison™ app.
☆	Customize the function of this key on the Vantage app.

Other general keyboard shortcuts

Key / key combination	Function description
	<ul style="list-style-type: none">• Launch Copilot in Windows.• Launch Windows Search. Note: The function varies by countries or regions.
Fn+ 	Open the context menu of the current active app.
Fn+ 	Adjust the keyboard backlight.
Fn+<	Go to beginning.
Fn+>	Go to end.
Fn+Tab	Open Magnifier. Note: Press the Windows logo key+Esc to turn it off.
Fn+4	Enter sleep mode.
Fn+B	Break operation.
Fn+K	Scroll contents.
Fn+P	Pause operation.
Fn+S	Send system request.
Fn+N	Open system information Window.
Fn+G	Enable / Disable the tapping gesture to launch TrackPoint Quick Menu.

You can customize keyboard settings in Vantage app. To customize detailed settings, open the Vantage app, and then click **Device → Input & Accessories**.

For more keyboard shortcuts, go to <https://support.lenovo.com/solutions/windows-support>.

Use the TrackPoint pointing device

The TrackPoint pointing device enables you to perform all the functions of a traditional mouse, such as pointing, clicking, and scrolling.

For Haptic Touchpad

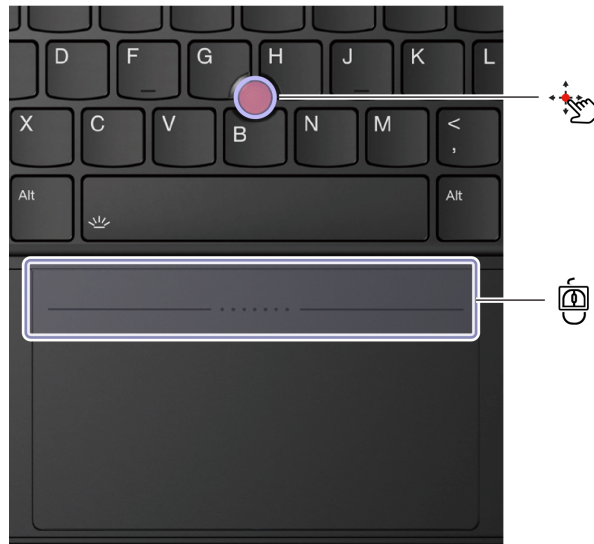

For Trackpad

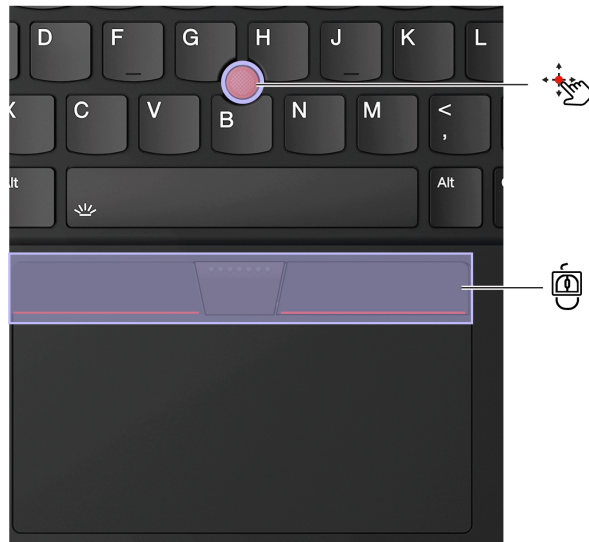

TrackPoint pointing stick

Use your finger to apply pressure to the pointing-stick nonslip cap (hereafter referred to as the red cap) in any direction parallel to the keyboard. The pointer on the screen moves accordingly. The higher the pressure applied, the faster the pointer moves.

Your computer supports TrackPoint Quick Menu, see “TrackPoint Quick Menu” on page 23.



TrackPoint Three Buttons

The left-click button and right-click button correspond to the left and right buttons on a traditional mouse. Press and hold the TrackPoint center button while using your finger to applying pressure to the pointing stick in the vertical or horizontal direction. Then, you can scroll through the document, Web site, or apps.

Press Ctrl+TrackPoint center button+TrackPoint pointing stick at the same time to zoom in or zoom out.

Disable the TrackPoint pointing device

The TrackPoint pointing device is enabled by default. You can disable the device and change settings such as the speed of cursor when using the TrackPoint pointing stick and the TrackPoint center button.

To change the settings, do the following:

Step 1. Type **Mouse settings** in the Windows search box and then press Enter.

Step 2. Click **TrackPoint settings** and then follow the on-screen instructions to change the settings.

Replace the pointing-stick nonslip cap

Follow below illustration to replace the pointing-stick nonslip cap.

Note: Ensure that the new red cap has grooves **a**.

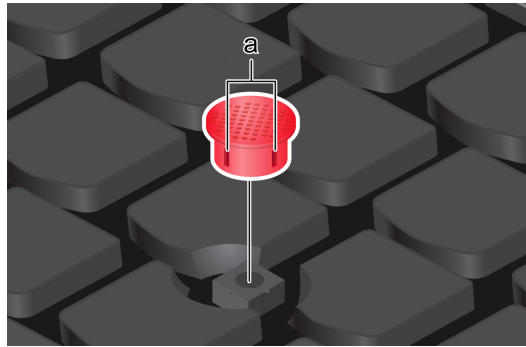

Use the Haptic Touchpad (for selected models)

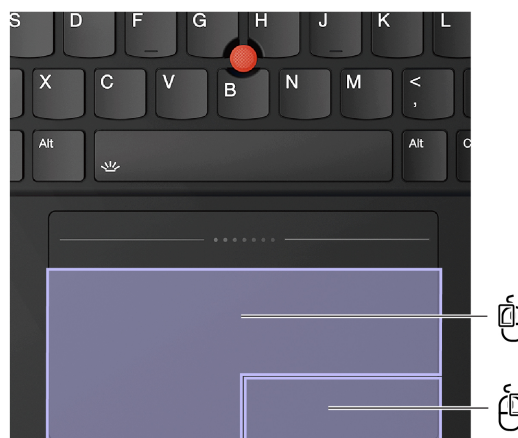

You can use the Haptic Touchpad to perform all the pointing, clicking, and scrolling functions of a traditional mouse. It is ideal for you to use for occasions with high portability requirements, for example, business trips.

- When TrackPoint Three Buttons are enabled



- When TrackPoint Three Buttons are disabled



Item	Description	Item	Description
	Left-click zone		Right-click zone



Notes:

- When using two or more fingers, ensure that you position your fingers slightly apart.
- Some gestures are not available if the last action was done from the TrackPoint pointing device.
- Some gestures are only available when you are using certain apps.
- If the Haptic Touchpad surface is stained with oil, turn off the computer first. Then, gently wipe the Haptic Touchpad surface with a soft and lint-free cloth moistened with lukewarm water or computer cleaner.

Use the Trackpad (for selected models)

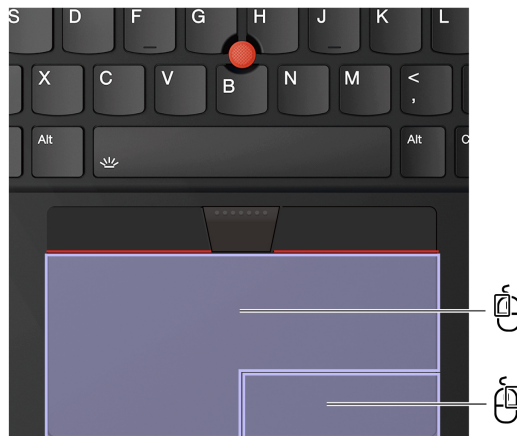
You can use the Trackpad to perform all the pointing, clicking, and scrolling functions of a traditional mouse. It is ideal for you to use for occasions with high portability requirements, for example, business trips.



Item	Description	Item	Description
	Left-click zone		Right-click zone

Notes:

- Some gestures are not available in the following cases:
 - if the last action was done from the TrackPoint pointing device.
 - when you are using certain apps.

- when you are using two or more fingers and your fingers are too close.
- Trackpad might be insensitive in the following cases:
 - when you position your fingers too close to the edge of Trackpad.
 - when you touch the Trackpad with wet fingers.
 - if the Trackpad surface is stained with water or oil. Turn off the computer first. Then, gently wipe the Trackpad surface with a soft and lint-free cloth that is moistened with lukewarm water or computer cleaner.

Use the touch gestures

Notes:

- When using two or more fingers, ensure that you position your fingers slightly apart.
- Some gestures are not available if the last action was done from the TrackPoint pointing device.
- Some gestures are only available when you are using certain apps.
- If the Trackpad surface is stained with oil, turn off the computer first. Then, gently wipe the Trackpad surface with a soft and lint-free cloth moistened with lukewarm water or computer cleaner.

For more gestures, see the help information of the pointing device.

One-and-two-finger touch gestures

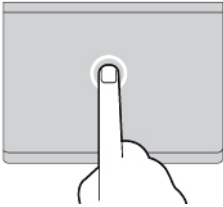
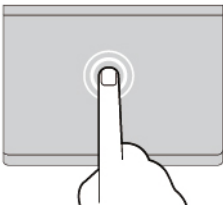
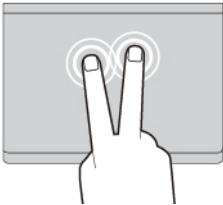
To do this	Gesture
Select an item.	One finger taps once. 
Open an item.	One finger taps twice. 
Display a shortcut menu.	Two fingers tap twice quickly. 

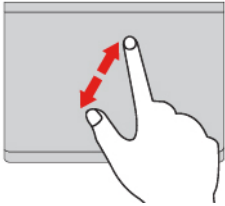
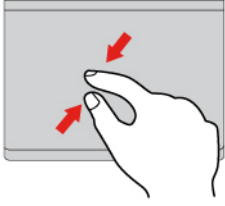
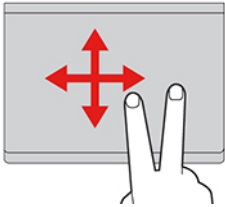
To do this	Gesture
Zoom in.	<p data-bbox="1019 224 1269 254">Two fingers stretch out.</p> 
Zoom out.	<p data-bbox="1036 514 1253 543">Two fingers pinch in.</p> 
Scroll through items.	<p data-bbox="927 808 1362 837">Two fingers slide horizontally or vertically.</p> 

Three-and-four-finger touch gestures

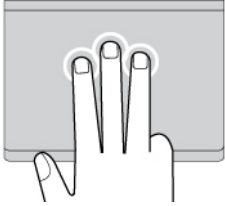
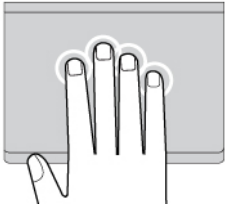
To do this	Gesture
Open search window.	<p data-bbox="1024 1220 1268 1249">Three fingers tap once.</p> 
Open notification center.	<p data-bbox="1027 1509 1265 1539">Four fingers tap once.</p> 

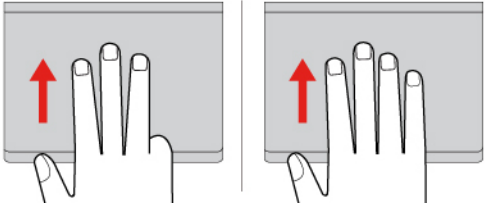
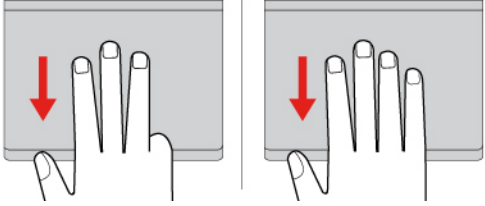
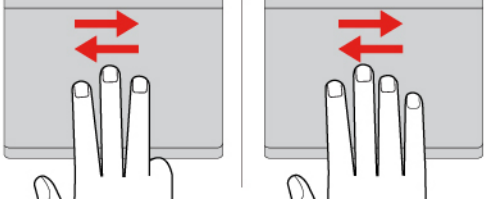
To do this	Gesture
Show all windows.	<p data-bbox="948 226 1281 254">Three- or four-finger swipes up.</p> 
Show the desktop.	<p data-bbox="932 520 1297 548">Three- or four-finger swipes down.</p> 
Switch between open apps or windows.	<p data-bbox="906 812 1330 840">Three- or four-finger swipes left or right.</p> 

Disable the Trackpad or Haptic Touchpad

The Trackpad or Haptic Touchpad is enabled by default. To disable the Trackpad or Haptic Touchpad:

Step 1. Open the **Start** menu, and then click **Settings** → **Bluetooth & devices** → **Touchpad**.

Step 2. In the **Touchpad** section, turn off the **Touchpad** control.

Connect to an external display

Connect your computer to a projector or a monitor to give presentations or expand your workspace.

Note: It's not recommended that you connect or disconnect the external display when in pre-OS environment. Otherwise, your computer screen might go black.

Connect to a wired display

You can connect a wired display with your computer through the USB-C connector or HDMI connector.

If your computer cannot detect the external display, right-click a blank area on the desktop and select **Display settings**. Then follow the on-screen instructions to detect the external display.

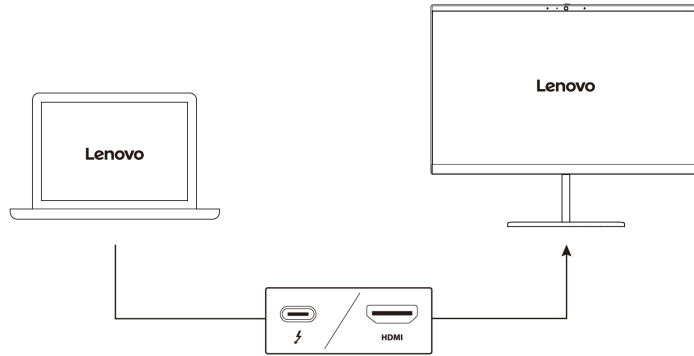

Supported resolution

The following table lists the supported maximum resolution of the external display.

Connect the external display to	Supported resolution
USB-C connector (Thunderbolt 4)	Up to 8K / 60 Hz
HDMI connector	Up to 4K / 60 Hz

Note: The refresh rate higher than 60 Hz can also be supported. If you set the refresh rate higher than 60 Hz, the maximum resolution might be limited.

Connect to a wireless display

To use a wireless display, ensure that both your computer and the external display support the Miracast® feature.

Press Windows logo key+K and then select a wireless display to connect with.

Set the display mode

Press or Fn key+ and then select a display mode of your preference.

Change display settings

You can change the settings for both the computer display and the external display, such as the main or the secondary display, brightness, resolution, and orientation.

To change the settings, do the following:

- Step 1. Right-click a blank area on the desktop and select **Display settings**.
- Step 2. Select the display that you want to configure and change display settings of your preference.

Chapter 3. Explore your computer

This chapter helps you get full use of your computer.

Lenovo apps

This section introduces Lenovo apps that can enrich your computing experience and improve productivity.

Lenovo Commercial Vantage

The Lenovo Commercial Vantage app (hereafter referred to as Vantage app) is a customized one-stop solution to help you maintain your computer with automated updates and fixes, configure hardware settings, and get personalized support.

To access the Vantage app, type **Lenovo Commercial Vantage** in the Windows search box.

Notes:

- The available features vary depending on the computer model.
- The Vantage app makes periodic updates of the features to keep improving your experience with your computer. The description of features might be different from that on your actual user interface. Ensure that you use the latest version of Vantage app, and apply Windows Update to get the latest updates.

The Vantage app enables you to:

- Know the device status easily and customize device settings.
- Download and install UEFI BIOS, firmware, and driver updates to keep your computer up-to-date.
- Monitor your computer health, and secure your computer against outside threats.
- Scan your computer hardware and diagnose hardware problems.
- Look up warranty status (online).
- Access *User Guide* and helpful articles.
- Temporarily disable the keyboard, screen, Trackpad, and TrackPoint pointing device for cleaning.

TrackPoint Quick Menu

TrackPoint Quick Menu is a clickable app. It offers rapid access to functions, such as camera and microphone. You can adjust the function settings in this app.

Launch the TrackPoint Quick Menu

Double-tap the TrackPoint pointing stick to launch the TrackPoint Quick Menu. You can also set single-tapping as the launch gesture.

Note: If the TrackPoint Quick Menu does not pop up after you use the launch gesture, this case might be caused by the displacement of the TrackPoint pointing stick due to too much force applied on it. Wait 15 to 30 seconds and try again.

To change the settings, do the following:

- Step 1. Click the flyout  and click **ADVANCED SETTINGS**.
- Step 2. Select **Single-tapping** under **TrackPoint Quick Menu Launch**.

The TrackPoint Quick Menu is enabled by default. Press Fn+G to disable or enable the tapping gesture. When disabled, it cannot be launched by tapping the TrackPoint pointing stick.



Use the TrackPoint Quick Menu

You can click the edit button  to rearrange the features in the preview panel, or drag and drop the features on the right to the preview panel to customize your quick menu.

- **Camera**

You can adjust the brightness and contrast of the camera, and restore the settings to default by tapping the reset button .

- **Microphone**

You can mute your computer, and adjust the sound effect of your microphone by selecting the following modes:

- Center mode: Capture the speaker's voice.
- Spatial mode: Capture the speaker's voice and the ambience.

Note: When internal microphone is not supported by Dolby or the Dolby driver is disabled, an input device list will be displayed instead. The list provides options and one volume bar to test your microphone.

- **Voice typing**

You can convert the speech to text in the text box. Click **START VOICE TYPING** to invoke the text box.

- **Battery**

You can extend the battery lifespan and health by setting the charging threshold below 100%.

To set the threshold, enable the feature and click **ADJUST THRESHOLD**. Then set the charge threshold in the Vantage app.

- **Audio playback**

You can select the output device of your preference and set the volume of your selected channel or mute it.

- **Noise suppression**

You can suppress your own background noise and the noise from other meeting participants.

- Off: Disable noise suppression.
- Low: Suppress low-level background noise.

- High: Suppress all non-speech background noise.

Note: The feature does not work when Dolby Voice is off. Click the link in **NOISE SUPPRESSION** to help you enable it.

- **Enable Haptic Touchpad button area (for selected models)**

You can enable or disable the TrackPoint Three Buttons. When the Haptic Touchpad button area is enabled, it works as the TrackPoint Three Buttons corresponding to the left and right buttons on a traditional mouse. When the Haptic Touchpad button area is disabled, it becomes part of the Haptic Touchpad. You can also click **ADVANCED SETTINGS** to enter OS settings to customize your Haptic Touchpad features.

- **Quick Clean**

You can temporarily disable the keyboard, screen, Haptic Touchpad, and TrackPoint pointing device to clean your computer.

Note: The features might vary due to periodic updates. For details of the version installed on your computer, click the flyout ⓘ at the top-right corner of the page and click **LEARN MORE**.

Smart experiences

Lenovo AURA EDITION experiences provide some smart features such as Smart Modes, Smart Share, and Smart Care to elevate your using experience with your computer.

- **Smart Modes:** Collect your commonly used settings to an easily accessed widget to promote your working efficiency.
- **Smart Share:** Support instant sharing and collaboration between mobile devices and your computer without operating system limitation.
- **Smart Care:** Provide live Lenovo support from mobile or computer to troubleshoot at any time.

Smart Modes

Smart Modes is a productivity widget to quickly activate the following commonly used features for different use scenarios:

- Enhance data security and privacy.
- Minimize distractions to keep you on track.
- Improve your virtual meeting experience (available when the webcam privacy shutter is open).
- Promote eye health and ergonomics.
- Help balance battery life and high performance.

Access the Smart Modes widget

Press F8 to launch the Smart Modes widget. Press F8 again to hide.

Activate the desired mode in the Smart Modes widget

1. Press F8 to launch the Smart Modes widget.
2. If it is the initial use of Smart Mode, you need to enable features you prefer for each mode in the Vantage app first:
 - a. Click the settings gear icon on top right of the widget to launch the Vantage app.
 - b. Locate the **Smart Modes** section. Select a mode and enable the features of the selected mode as you prefer.
 - c. Exit the Vantage app.

3. Click the mode you prefer in the Smart Modes widget to quickly active the features you have configured in the Vantage app.

Notes:

- The available features vary depending on the computer model.
- The Lenovo View service and Vantage app periodically updates features to improve your camera and video call experience. The feature description might be different from that on your actual user interface.

Smart Share

The Smart Share function supports fast and convenient photo sharing between your computer and phones (both iOS and Android supported).

To get the Smart Share experience:

1. Ensure the following:
 - The Intel Unison app is installed on both your computer and the phone. Download the app for free from the app store.
 - Pair the phone with your computer through Bluetooth and follow the on-screen instructions to finish initial settings on both devices.
2. Launch Smart Share by one of the following:
 - Launch the Intel Unison on your computer, and then tap your paired phone against the left or right side of your computer display.
 - Press F11 to launch Smart Share.

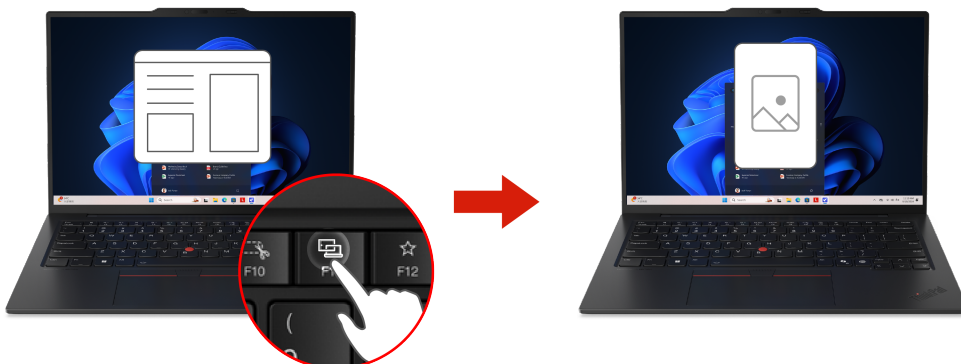

3. Follow the on-screen instructions on the app, and then drag and drop photos between your paired computer and phone for editing and sharing.

Notes:

- The available features might vary depending on the computer model.
- The Intel Unison app makes periodic updates for the features to improve your experience with your computer.

Smart Care

Smart Care is a unified software solution to provide prompt support from Lenovo support experts, eliminating the need for multiple platforms. In Smart Care, you can get help from Lenovo on hardware and software solutions using your computer or mobile devices with intuitive interfaces.

To access Smart Care, open the Vantage app, and then click **Smart Care** from the side panel menu.

Key features:

- Check, renew, or upgrade warranty.
- Get in-time support from Lenovo through multiple channels. For example, you can query BIOS problems through a live chat, a live call or even sharing your screen. If you want to query your issue later, you can schedule a callback or submit a ticket.

Note: The availability of these services depends on your warranty, country or region, and language.

- Explore Lenovo knowledge base, including user guides, feature articles, and feature videos.
- Diagnose and troubleshoot an issue step by step to help you quickly identify and resolve the issue.

Note: The Smart Care features will not be available if the Vantage app is uninstalled.

Copilot in Windows

Copilot in Windows is an AI-powered assistant to help enhance work efficiency and creativity.

To access Copilot in Windows, do one of the following:

- Press the Copilot key .
- Click the Copilot icon  on the task bar.

Key functions

- Provide answers or suggestions to your questions through live chat. For example, you could ask Copilot how to change your Windows password.
- Assist you to analyse image by clicking the image button at the bottom right of the chat box. For example, you could ask Copilot to summarize the image you have uploaded.

Notes:

- This app might not be available in your country or region.
- This app makes periodic updates of the features. Explore this app on your actual user interface.

Global Power Management

Global Power Management provides power saving functions such as Intelligent Cooling, Efficiency Optimizer and Brightness Control. It helps improve your computer performance.

Access Global Power Management

Open the Vantage app, and then click **Device** → **Power**.



Explore the features

- **Intelligent Cooling:** Help you adjust power consumption, fan speed, computer temperature, and performance.

Mode	Recommended scenario
Best power efficiency	<ul style="list-style-type: none">– You want the computer to be quieter and cooler.– You want to maximize the battery life.
Balanced	<ul style="list-style-type: none">– You plan to frequently switch between different computer tasks over a period time.– You prefer to balance device performance with temperature and fan noise.
Best performance	<ul style="list-style-type: none">– You want the computer to achieve the best performance.– Louder fan noise and higher temperature are acceptable to you.

- **Efficiency Optimizer:** Optimize CPU power based on your system's responsiveness. It can improve your battery life while reducing power consumption, fan noise, and heat.
- **Brightness Control:** Reduce power consumption by automatically lowering the display brightness while on battery power.

Enable the features

- **Intelligent Cooling:** Balanced mode is the default setting. To switch among power modes, do one of the following:
 - In Vantage:
 1. Press F8 to launch Smart Modes widget.
 2. Select a preferred power mode.
 - In OS settings:
 1. Right-click the battery icon in the quick settings area    on the right side of the taskbar.
 2. Click **Power and sleep settings**.
 3. Locate the **Power mode** section and select a preferred mode.
- **Efficiency Optimizer** : Turn on the feature switch under **Global Power Management**.
- **Brightness Control:** Turn on the feature switch under **Global Power Management**.

Cool and Quiet on Lap

Your computer can detect whether you are using it on your lap and automatically enable the Cool and Quiet on Lap feature when in **Best performance** mode. The feature helps cool down your computer to avoid any discomfort caused by extended contact with your body, even through clothing. When you are not using it on your lap, the feature will be disabled automatically.

Transfer data

Quickly share your files using the built-in Bluetooth or NFC technology among devices with the same features.

Connect to a Bluetooth device

You can connect all types of Bluetooth-enabled devices to your computer, such as a keyboard, a mouse, a smartphone, or speakers. To ensure successful connection, place the devices at most 10 meters (33 feet) from the computer.

Conventional pair

This topic helps you connect to a Bluetooth device by conventional pair.

- Step 1. Type **Bluetooth** in the Windows search box and then press Enter.
- Step 2. Turn on both the Bluetooth on your computer and the Bluetooth device. Make sure the device is discoverable.
- Step 3. Select the device when it is displayed on the **Add device** list, and then follow the on-screen instructions.

Swift pair

This topic helps you connect to a Bluetooth device by swift pair.

If your Bluetooth device supports swift pair, do the following:

- Step 1. Enable swift pair notification on Bluetooth settings page.
- Step 2. Turn on both the Bluetooth on your computer and the Bluetooth device. Make sure the device is discoverable.
- Step 3. Click **Connect** when a swift pair notification appears on your computer.

Chapter 4. Secure your computer and information

Your computer can safeguard your privacy and information through some privacy protection functions.

Lock the computer

Lock your computer to a desk, table, or other fixtures through a compatible security cable lock.

Note: The slot supports cable locks that conform to the Kensington NanoSaver® lock standards using Cleat™ locking technology. You are responsible for evaluating, selecting, and implementing the locking device and security feature. Lenovo is not responsible for the locking device and security feature. You can purchase the cable locks at <https://smartfind.lenovo.com>.

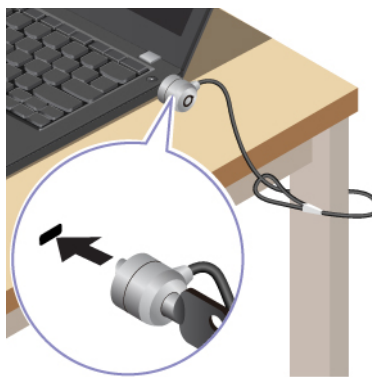

Log in with fingerprint recognition

You can log in to the computer with your fingerprint. It eliminates the need to enter complex passwords, saving your time and boosting your productivity.

To enroll your fingerprints, do the following:

- Step 1. Type **Sign-in options** in the Windows search box and then press Enter.
- Step 2. Select **Fingerprint recognition (Windows Hello)** and then follow the on-screen instruction to enroll your fingerprint.

Note: It is recommended that you put your finger at the center of the fingerprint reader key during enrollment and enroll more than one fingerprint in case of any injuries to your fingers. After the enrollment, the fingerprints are associated with the Windows password automatically.

- Step 3. Log in with your fingerprint.



Note: You can associate your fingerprints with your power-on password and NVMe password. See “Associate your fingerprints with passwords” on page 35.

Maintenance tips:

- Do not scratch the surface of the reader with anything hard or sharp.
- Do not use or touch the reader with a wet, dirty, wrinkled, or injured finger.

Log in with facial recognition

You can log in to the computer with your facial recognition. It provides precise and secure authentication.

For models come with a webcam privacy shutter, slide the webcam privacy shutter to uncover the camera lens before using the Windows Hello face recognition.

Set up facial recognition and unlock your computer by scanning your face:

Step 1. Type **Sign-in options** in the Windows search box and then press Enter.

Step 2. Select **Facial recognition (Windows Hello)** and then follow the on-screen instruction to enroll your facial ID.

Lock on leave function

Your computer supports the lock on leave function with ultrasound-based human presence detection, providing added security and improving battery life.



Change the settings

To enable or disable this function:

Step 1. Go to **Start → Power & battery**.

Step 2. Turn on or turn off the **Turn off my screen when I leave** switch.

UEFI BIOS passwords

You can set passwords in UEFI (Unified Extensible Firmware Interface) BIOS (Basic Input/Output System) to strengthen the security of your computer.

Password types

You can set a power-on password, supervisor password, system management password, or NVMe password in UEFI BIOS to prevent unauthorized access to your computer.

However, you are not prompted to enter any UEFI BIOS password when your computer resumes from sleep mode.

Power-on password

If you set a power-on password, a window is displayed on the screen when you turn on the computer. Enter the correct password to use the computer.

Supervisor password

The supervisor password protects the system information stored in UEFI BIOS. When entering the UEFI BIOS menu, enter the correct supervisor password in the window prompted. You also can press Enter to skip the password prompt. However, you cannot change most of the system configuration options in UEFI BIOS.

If you have set both the supervisor password and power-on password, you can use the supervisor password to access your computer when you turn it on. The supervisor password overrides the power-on password.

NVMe passwords

The NVMe password prevents unauthorized access to the data on the storage drive. When an NVMe password is set, you are prompted to type a correct password each time you try to access the storage drive.

- **Single Password**

When a Single NVMe password is set, the user must enter the user NVMe password to access files and applications on the storage drive.

- **Dual Password (User+Admin)**

The admin NVMe password is set and used by a system administrator. It enables the administrator to access any storage drive in a system or any computer connected in the same network. The administrator can also assign a user NVMe password for each computer in the network. The user of the computer can change the user NVMe password as desired, but only the administrator can remove the user NVMe password.

When prompted to enter an NVMe password, press F1 to switch between the admin NVMe password and user NVMe password.

Notes: The NVMe password is not available in the following situations:

- A Trusted Computing Group (TCG) Opal-compliant storage drive and a TCG Opal management software program are installed in the computer, and the TCG Opal management software program is activated.

- An eDrive storage drive is installed in the computer preinstalled with the Windows operating system.

System management password

The system management password can also protect the system information stored in UEFI BIOS like a supervisor password, but it has lower authority by default. The system management password can be set through the UEFI BIOS menu or through Windows Management Instrumentation (WMI) with the Lenovo client-management interface.

You can enable the system management password to have the same authority as the supervisor password to control security-related features. To customize the authority of the system management password through the UEFI BIOS menu:

- Step 1. Restart the computer. When the logo screen is displayed, press F1 to enter the UEFI BIOS menu.
- Step 2. Select **Security → Password → System Management Password Access Control**.
- Step 3. Follow the on-screen instructions.

If you have set both the supervisor password and the system management password, the supervisor password overrides the system management password. If you have set both the system management password and the power-on password, the system management password overrides the power-on password.

Set, change, or remove a password

Follow the instructions to set, change or remove a password.

Before you start, print these instructions.

- Step 1. Restart the computer. When the logo screen is displayed, press F1 to enter the UEFI BIOS menu.
- Step 2. Select **Security → Password** by using the arrow keys.
- Step 3. Select the password type. Then, follow the on-screen instructions to set, change, or remove a password.

You should record all your passwords and store them in a safe place. If you forget any of your passwords, any potential repair actions required are not covered under warranty.

What to do if you forget your power-on password

Follow the instructions to remove the power-on password if you forget your power-on password.

If you have set a supervisor password or a system management password and remember it:

- Step 1. Restart the computer. When the logo screen is displayed, immediately press F1.
- Step 2. Type the supervisor password or the system management password to enter the UEFI BIOS menu.
- Step 3. Select **Security → Password → Power-On Password** by using the arrow keys.
- Step 4. Type the current supervisor password or the system management password in the **Enter Current Password** field. Then, leave the **Enter New Password** field blank, and press Enter twice.
- Step 5. In the Changes have been saved window, press Enter.
- Step 6. Press F10 to save changes and exit the UEFI BIOS menu.

If you have not set a supervisor password or a system management password, contact a Lenovo-authorized service provider to have the power-on password removed.

What to do if you forget your system management password

Follow the instructions to remove the system management password if you forget your system management password.

If you have set a supervisor password and remember it:

- Step 1. Restart the computer. When the logo screen is displayed, immediately press F1.
- Step 2. Type the supervisor password to enter the UEFI BIOS menu.
- Step 3. Select **Security → Password → System Management Password** by using the arrow keys.
- Step 4. Type the current supervisor password in the **Enter Current Password** field. Then, leave the **Enter New Password** field blank, and press Enter twice.
- Step 5. In the Changes have been saved window, press Enter.
- Step 6. Press F10 to save changes and exit the UEFI BIOS menu.

If you have not set a supervisor password, contact a Lenovo-authorized service provider to have the system management password removed.

What to do if you forget your NVMe password

Follow the instructions to remove the NVMe password if you forget your NVMe password.

If you forget your NVMe password (Single password) or both user and admin NVMe passwords (Dual password), Lenovo cannot reset your passwords or recover data from the storage drive. You can contact a Lenovo-authorized service provider to have the storage drive replaced. A fee will be charged for parts and service. If the storage drive is a CRU (Customer Replaceable Unit), you can also contact Lenovo to purchase a new storage drive to replace the old one by yourself. To check whether the storage drive is a CRU and the relevant replacement procedure, see “CRU list” on page 79.

What to do if you forget your supervisor password

Follow the instructions to remove the supervisor password if you forget your supervisor password.

There is no service procedure to remove the password. You can contact a Lenovo-authorized service provider to have the system board replaced. A fee will be charged for parts and service.

Associate your fingerprints with passwords

You can associate the fingerprints with passwords to get quick access to the computer and the data on the storage drive without entering the power-on password or NVMe password.

Do the following to associate your fingerprints with the power-on password and NVMe password:

- Step 1. Turn off and then turn on the computer.
- Step 2. When prompted, scan your finger on the fingerprint reader.
- Step 3. Enter your power-on password, NVMe password, or both as required. The association is established.

When you start the computer again, you can use your fingerprints to log in to the computer without entering your Windows password, power-on password, or NVMe password. To change settings, press F1 to enter the UEFI BIOS menu, and then select **Security → Fingerprint**.

Attention: If you always use your fingerprint to log in to the computer, you might forget your passwords. Write down your passwords, and keep them in a safe place.

Protect data against power loss

NVMe (Non-Volatile Memory express) M.2 solid-state drive features the Lenovo-unique PLP (Power Loss Protection) function to avoid data loss or damage.

If your computer is not responding and you might have to shut down your computer by pressing and holding the power button for several seconds. In this case, the PLP function enables your computer data to be saved timely. However, there is no guarantee that all data is saved in any situation.

To check the type of your M.2 solid-state drive:

- Step 1. Restart the computer. When the logo screen is displayed, press F10 to enter the Lenovo diagnostics window.
- Step 2. On the TOOLS tab, select **SYSTEM INFORMATION** → **STORAGE** using the arrow keys.
- Step 3. Locate the **Device Type** section to check the information.

USB-C Restricted Mode

USB-C Restricted Mode is a security feature that allows you to disable data transfer through USB-C connectors while the charge function of the USB-C connectors is kept. It helps prevent data from being copied from the computer to USB storage devices connected to the computer. By enabling this feature, you can use public USB charging stations, such as those found in cafes and hotel lobbies, without worrying about data leakage from the USB-C connector.

Notes:

- Before using this feature, ensure that the remaining battery power is not less than 5%. Otherwise, this feature can not be enabled.
- This feature can be enabled or disabled by key combinations only when the computer is turned on.

To enable or disable this feature, press Fn+U, and then press Fn+S.

After this feature is enabled, the LED indicator blinks briefly when a USB device is connected.

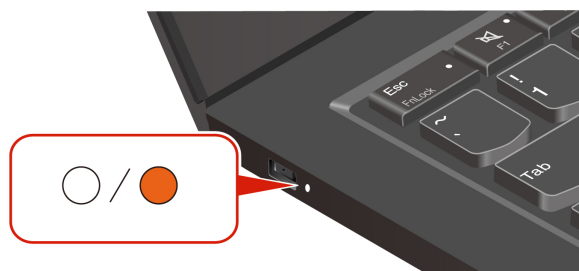

FIDO (Fast Identity Online) authentication

Your computer supports FIDO (Fast Identity Online) authentication feature. This feature works as an alternative to password-based authentication to achieve passwordless authentication.

This feature only works when a power-on password is set in UEFI BIOS and the FIDO2 USB device is registered in ThinkShield™ Passwordless Power-On Device Manager. With this feature, you can input the power-on password or use the registered FIDO2 USB device to power on your computer.

Register FIDO2 USB device in ThinkShield Passwordless Power-On Device Manager

Follow the instructions to register FIDO2 USB device in ThinkShield Passwordless Power-On Device Manager.

- Step 1. Turn on the computer.
- Step 2. Press F12 during the power-on process.
- Step 3. If you set a power-on password, you are prompted to enter the correct password.
- Step 4. Select **App Menu → ThinkShield Passwordless Power-On Device Manager** and press Enter
- Step 5. Insert the FIDO2 USB device to register the device by following steps:
 - a. Select the available FIDO2 USB device that you want to register in the **Discovered Devices** field.
 - b. Click **Yes** in the displayed window to confirm the device you selected
 - c. If you set a power-on password, you are prompted to enter the correct password.
 - d. The **User operation request** window is displayed. You are prompted to press the button on the connected FIDO2 USB device, and then follow the on-screen instructions to close the window.
 - e. Press Esc to exit and restart your computer.

Notes:

- If you want to unregister your devices, click the available FIDO2 USB device that you want to unregister in the **My Device** field and enter the correct power-on password for verification.
- If you use more than one FIDO2 USB device with a common identifier for registration, only one device is available.

Log in to the System with Passwordless Power-On Authentication

Follow the instructions to log in to the System with Passwordless Power-On Authentication.

- Step 1. Restart the computer.
- Step 2. **ThinkShield Passwordless Power-On Authentication** window is displayed.
- Step 3. Insert your registered FIDO2 USB device for detection.
- Step 4. Then follow the on-screen instructions to press the button on your FIDO2 USB device for verification.
- Step 5. After your device is verified, the power-on process continues.

Note: You should insert the FIDO2 USB device or enter the power-on password within 60 seconds. Otherwise, your computer will shut down automatically.

Chapter 5. Configure advanced settings

UEFI BIOS

UEFI BIOS is the first program that the computer runs. When the computer turns on, the UEFI BIOS performs a self test to make sure that various devices in the computer are functioning properly.

Enter the UEFI BIOS menu

Turn on or restart the computer. When the logo screen is displayed, press F1 repeatedly to enter the UEFI BIOS menu.

Navigate the UEFI BIOS menu

Follow the on-screen instructions to navigate in the UEFI BIOS menu.

The table below introduces some available settings of the UEFI BIOS menu. To know more about the UEFI BIOS, for example, BIOS Event log, you can go to <https://pcsupport.lenovo.com> and then type **UEFI BIOS** in search box.

Note: The UEFI BIOS menu might vary depending on system configurations.

Menu	Introduction
Main	This category displays the general product-related information, such as UEFI BIOS version, machine type, system serial number, preinstalled OS license, and BIOS Event log.
Config	This category enables you to update configurations relating to system settings such as network, USB, keyboard, display, CPU, and power.
Date/Time	This category enables you to set computer date and time in this category.
Security	This category enables you to configure security settings related to such as password, fingerprint, and I/O accessibility.
Startup	This category enables you to manage settings relevant to booting up.
Restart	This category enables you to save or discard changes before exiting.

You can go to Lenovo BIOS Simulator Center <https://download.lenovo.com/bSCO/index.html> to explore the detailed settings by your product name.

Note: The Lenovo BIOS Simulator Center makes periodic updates of the settings. The UEFI BIOS simulator interface and description of settings might be different from that on your actual user interface.

Customize BIOS Defaults

The feature provides a solution to backup your preferred BIOS Setup settings.

It helps you to save the BIOS Setup settings as customized BIOS default settings, load them to current BIOS settings when needed, and reset the settings to Setup Defaults.

Save the customized settings configuration

Follow the instructions to save the customized settings configuration.

Step 1. Restart the computer. When the logo screen is displayed, press F1 to enter the UEFI BIOS menu.

- Step 2. Select **Restart → Save Custom Defaults**.
- Step 3. Click **Yes** to save the settings configuration you customized.

Load the customized settings configuration

Follow the instructions to load the customized settings configuration.

- Step 1. Restart the computer. When the logo screen is displayed, press F1 to enter the UEFI BIOS menu.
- Step 2. Select **Restart → Load Custom Defaults**.
- Step 3. Click **Yes** to load the customized settings configuration you saved.

You can also press F9 and click **Custom Defaults** to load the customized settings configuration.

Note: **Load Custom Defaults** is unavailable if no customized BIOS default settings are saved.

Reset the settings configuration to Setup Defaults

Follow the instructions to reset the settings configuration to Setup Defaults.

- Step 1. Restart the computer. When the logo screen is displayed, press F1 to enter the UEFI BIOS menu.
- Step 2. Select **Restart → Load Factory Defaults**.
- Step 3. Click **Yes** to reset the settings configuration to Setup Defaults.

You can also press F9 and click **Factory Defaults** to reset the settings configuration to Setup Defaults.

ThinkShield secure wipe

ThinkShield secure wipe feature is ThinkPad Drive Erase Utility for the Resetting the Cryptographic Key and the Erasing the Solid State Drive. This feature provides you a secure method to wipe all the data on your computer.

- Step 1. Restart the computer. When the logo screen is displayed, press F12.
- Step 2. Select **App Menu → ThinkShield secure wipe**, and then follow the on-screen instructions.

Detect memory retraining

Memory retraining is a process to initialize the memory module and run diagnostic tests for the memory module in your computer.

The memory retraining might occur during POST if any of the following situations is detected:

- Total Memory Encryption setting change in the UEFI BIOS
- Memory Reference Code (MRC) change when the UEFI BIOS updates

When memory retraining occurs, the screen might be blank. You might see the LED indicators on Esc, F1, and F4 blinking sequentially to indicate the progress. Do not press the power button to interrupt the process. Wait a few minutes until the logo screen is displayed.

Chapter 6. Frequently asked questions

This chapter provides solutions to some hardware and software issues.

Camera problems

Follow the instructions to troubleshoot the corresponding camera problems.

Why can't my camera be launched or found?

- Your camera might be disconnected or covered:
 - If you are using an external camera, ensure that you have connected it to a working USB connector on your computer.
 - If you are using an integrated camera, open the camera shutter.
- If you are using an integrated camera, it might be disabled. To enable your camera:
 1. Open the **Start** menu, and click **Settings** → **Bluetooth & devices** → **Camera**.
 2. Check if the camera is connected or disabled. If it is disabled, enable the camera.
- The apps you are using might not have access to your camera. To authorize access to your camera:
 1. Open the **Start** menu, and select **Settings** → **Privacy & security** → **Camera**.
 2. Turn on **Camera access** switch and **Let apps access your camera** switch.
- Your antivirus software settings might block access to your camera. Go to your antivirus software settings and unblock the access.
- Your camera driver might be uninstalled or out-of-date. To update the camera driver:
 1. Type **device manager** in the Windows search box and then press Enter.
 2. Click **Device Manager** from the list of results. The Device Manager window opens.
 3. Click arrow icon > next to **Camera** to expand the section.
 4. Right-click the camera that you would like to update.
 5. Select **Update driver** and follow the on-screen instructions.
- If your camera still does not work, run the automated camera troubleshooter in the Get Help app. To open the Get help app:
 1. Open the **Start** menu, and click **Settings** → **Privacy & security** → **Camera**.
 2. Scroll down to the bottom. Click **Get help** and follow the on-screen instructions.

If the problem persists, call Lenovo Customer Center for help. For a list of the latest numbers for your country or region, go to <https://pcsupport.lenovo.com/supportphonenumberlist>.

Keyboard problems

Follow the instructions to troubleshoot the corresponding keyboard problems.

What should I do if my keyboard is not working?

- Check if the keyboard is well connected.
 - If you are using a wired keyboard, check if it is connected to your computer correctly or try to connect the keyboard to another compatible connector on your computer.

- If you are using a wireless keyboard, ensure that your keyboard is powered on. Check if the dongle is connected to your computer correctly or the Bluetooth connection with your computer is established.
- Check if the keyboard is in good status:
 1. Type **device manager** in the Windows search box and then press Enter.
 2. Click **Device Manager** from the list of results. The Device Manager window opens.
 3. Click arrow icon > next to **Keyboard** to expand the section.
 4. Double-click the keyboard that is not working and check the status.
 5. If it is not working properly, select **Driver** from the tabs on the top and click **Uninstall device** to uninstall the device.
 6. Apply Windows Update to install the latest driver automatically.
- Ensure that the sticky keys and filter keys are disabled. To disable the keys:
 1. Open the **Start** menu, and click **Settings → Accessibility → Keyboard**.
 2. Disable **Sticky keys** switch and **Filter keys** switch.
- Clean the keyboard.
 - To clean the externally connected keyboard:
 1. Disconnect your keyboard.
 2. Turn the keyboard upside down and gently shake it.
 3. Use compressed air to blow out the dirt and debris from underneath the keys.
 4. Use a cotton swab dipped in rubbing alcohol to remove stickiness around and underneath stuck keys.
 - To clean the internal keyboard:
 1. Turn off your computer.
 2. Use compressed air to blow out the dirt and debris from underneath the keys.
 3. Use a cotton swab dipped in rubbing alcohol to remove stickiness around and underneath stuck keys.
- Restart your computer.

If the problem persists, call Lenovo Customer Center for help. For a list of the latest numbers for your country or region, go to <https://pcsupport.lenovo.com/supportphonenumber>.

Why is my keyboard backlight not working?

- Your keyboard backlight might be turned off or the backlight level might be low. To turn on or adjust the keyboard backlight, press Fn+space key to toggle among backlight on, backlight brighter and backlight off.
- Your keyboard driver might be uninstalled or out-of-date. To update the keyboard driver:
 1. Type **device manager** in the Windows search box and then press Enter.
 2. Click **Device Manager** from the list of results. The Device Manager window opens.
 3. Click arrow icon > next to **Keyboard** to expand the section.
 4. Right-click the keyboard you would like to update.
 5. Select **Update driver** and follow the on-screen instructions.

If the problem persists, call Lenovo Customer Center for help. For a list of the latest numbers for your country or region, go to <https://pcsupport.lenovo.com/supportphonenumber>.

USB problems

Follow the instructions to troubleshoot the corresponding USB problems.

Why is my USB connector not working?

- Your USB cable might be disconnected or have poor connection:
 - Check if the cable is connected properly to your computer.
 - Check if there are debris in your USB connector.
- Your USB connector might be broken. Try using a different one on your computer.
- If you are using a USB connector for charging but it does not work, the USB connector might transfer data only. Ensure that your USB connector supports charging function.
- Your **USB selective suspend setting** might be enabled. To disable the setting:
 1. Type **power plan** in the Windows search box and press Enter.
 2. Click **Edit power plan → Change advanced power settings**.
 3. Double-click **USB settings → USB selective suspend setting** to expand the menu.
 4. Disable **On battery** and **Plugged in** and click **Apply**.
 5. Restart your computer.
- Your computer might have some internal errors. Restart your computer.
- Your USB driver might be uninstalled or out-of-date. To update the driver:
 1. Type **device manager** in the Windows search box and then press Enter.
 2. Click **Device Manager** from the list of results. The Device Manager window opens.
 3. Click arrow icon > next to **Universal Serial Bus controllers** to expand the section.
 4. Right-click the USB device you would like to update.
 5. Select **Update driver** and follow the on-screen instructions.

If the problem persists, call Lenovo Customer Center for help. For a list of the latest numbers for your country or region, go to <https://pcsupport.lenovo.com/supportphonenumber>.

How to recover data from a USB drive?

- You can recover data by using command line.
 1. Connect the USB drive to your computer.
 2. Press Windows key+R to launch Windows Explorer.
 3. Type **CMD** in the search box and press Enter.
 4. Type **chkdsk E: /f** and press Enter.
Note: Replace E with your actual USB drive letter.
 5. Type **ATTRIB -H -R -S /S /D E:*.*** and press Enter.
Note: Replace E with your actual USB drive letter.
 6. Wait for the process to finish.

All the recovered files will be in a new folder on your USB drive after the process is complete.

Note: These files names might be with the extension “.chk”. You can change it into the original extension, for example, “.jpg”, and save the files to another location.

- If you have created a recovery USB drive as a backup for the Windows recovery programs, you can recover data by restoring to a previous version.
 1. Connect the USB drive to your computer and enter **This PC**.
 2. Right-click your USB drive and select **Properties**.
 3. Click **Previous Versions** and select an available previous version.
 4. Click **Restore to** and choose a new location to save the files.
- You can recover data by using a reliable USB data recovery tool.

If the problem persists, call Lenovo Customer Center for help. For a list of the latest numbers for your country or region, go to <https://pcsupport.lenovo.com/supportphonenumber>.

How to create a recovery drive?

Attention: The process of creating a recovery drive deletes all the data stored on the USB drive, including the data stored in a hidden folder.

1. Prepare a USB drive (at least 32 GB of storage).
2. Type **Create a recovery drive** in the Windows search box and then select it.
3. Ensure that **Back up system files to the recovery drive** is selected and then click **Next**.
4. Connect the USB drive to your computer, select it and then click **Next**.
5. Click **Create** to start the recovery drive creation process.

Battery problems

Follow the instructions to troubleshoot the corresponding battery problems.

What should I do if my computer battery is not recognized or the battery icon in the quick settings area disappeared?

If your computer cannot recognize the battery, let's try the following steps:



- Ensure that the ac power adapter, power cord, power connector, and the power outlet are working correctly.
- Restart the computer.
 - For models with an emergency reset hole: Insert a straightened paper clip into the emergency reset hole to cut off power supply temporarily. Then, restart the computer with ac power connected.
 - For models without an emergency reset hole, disconnect all power sources. Press and hold the power button for about seven seconds. Then, reconnect to ac power and restart the computer.
- Update the battery driver to the latest version. For details, refer to “Driver problems” in this *User Guide*.
- Update UEFI BIOS to the latest version. For details, refer to “UEFI BIOS problems” in this *User Guide*.

If the problem persists, call Lenovo Customer Center for help. For a list of the latest Lenovo Support phone numbers for your country or region, go to <https://pcsupport.lenovo.com/supportphonenumber>.

What should I do if my computer battery is discharging quickly?

If your laptop battery is discharging quickly, let's try the following steps:

- Terminate any power-consuming settings, operations, or running apps, such as:
 - Decrease the screen brightness
 - Turn off the keyboard backlight

- Disconnect unnecessary peripheral devices
- Ensure your computer is not set to high performance mode, which can consume more power. To change the settings:
 1. Click the quick settings area    on the right side of the taskbar.
 2. Click the battery icon to change the settings.
- Reset the battery gauge, which can help estimate the full charge capacity more accurately. To change the settings:
 1. Open the Vantage app, and then click **Device**→**Power**.
 2. Follow the on-screen instructions to reset the battery gauge.
- Update the battery driver to the latest version. For details, refer to “Driver problems” in this *User Guide*.
- If your laptop’s battery is old or drained, consider replacing the battery.

If the problem persists, call Lenovo Customer Center for help. For a list of the latest Lenovo Support phone numbers for your country or region, go to <https://pcsupport.lenovo.com/supportphonenumber>.

Fingerprint reader problems

Follow the instructions to troubleshoot the corresponding fingerprint reader problems.

What should I do when I cannot set up fingerprint recognition?

Ensure that your computer supports the fingerprint recognition. And then try the solutions in the order below:

- Restart the computer.
- Disconnect all power sources, and insert a straightened paper clip into the emergency reset hole for three to five seconds to cut off power supply temporarily. If your computer does not have the emergency reset hole, press and hold the power button for about seven seconds. Then start your computer again.
- Check the fingerprint device driver. To do this:
 1. Type **device manager** in the Windows search box.
 2. Click **Device Manager** from the list of results. The Device Manager window opens.
 3. Click arrow icon > next to **Biometric devices** to expand the section.
 - If there is no fingerprint device, it might be a fingerprint reader failing problem, and you might need to have the fingerprint reader serviced. You can call Lenovo Customer Support Center for help. For a list of the latest Lenovo Support phone numbers for your country or region, go to <https://pcsupport.lenovo.com/supportphonenumber>.
 - If there is a yellow exclamation mark next to the fingerprint device, update the fingerprint reader driver:
 - a. Download the latest driver from Lenovo support website. For how to download the driver, refer to “Driver problems” in this *User Guide*.
 - b. In the **Biometric devices** section of the Device manager, right-click the fingerprint device, and then click **Update driver**.
 - c. In the Update Drivers window, click **Browse my computer for drivers**.
 - d. Browse to the folder where the latest fingerprint driver is stored. Double-click to run the driver and then follow the on-screen instructions to update the driver.
 - e. Restart your computer.

If the problem persists, call Lenovo Customer Support Center for help. For a list of the latest Lenovo Support phone numbers for your country or region, go to <https://pcsupport.lenovo.com/supportphonenumberlist>.

What should I do when there is an error during enrollment?

The fingerprint reader driver on your computer might not be the latest. To update the fingerprint reader driver:

1. Download the latest driver from Lenovo support website. For how to download the driver, refer to “Driver problems” in this *User Guide*.
2. Update the fingerprint reader driver.
 - a. Type **device manager** in the Windows search box.
 - b. Click **Device Manager** from the list of results. The Device Manager window opens.
 - c. Click arrow icon > next to **Biometric devices** to expand the section.
 - d. Right-click the fingerprint driver, and then click **Update driver**.
 - e. In the Update Drivers window, click **Browse my computer for drivers**.
 - f. Browse to the folder where the latest fingerprint driver is stored. Double-click to run the driver and then follow the on-screen instructions to update the driver.
3. Restart your computer, and then enroll again.

If the problem persists, call Lenovo Customer Support Center for help. For a list of the latest Lenovo Support phone numbers for your country or region, go to <https://pcsupport.lenovo.com/supportphonenumberlist>.

What should I do when fingerprint recognition always fails?

During fingerprint recognition, ensure that you use the correct finger, and keep the fingertip and the surface of the fingerprint reader clean. If the problem persists, try the solutions in the order below:

- Remove the fingerprint, and enroll again. To do this:
 1. Click **Start** → **Settings** → **Accounts** → **Sign-in options** → **Fingerprint recognition (Windows Hello)**.
 2. Click **Remove** to remove the fingerprint. No matter how many fingers have been set, you only need to remove once.
 3. Enroll the fingerprint again. For how to enroll the fingerprint, refer to fingerprint recognition topic in this *User Guide*.

Note: During the enrollment, it is recommended that you follow the on-screen instructions to enroll the full image of your fingerprint.
- Update the fingerprint driver and enroll again. To do this:
 1. Download the latest driver from Lenovo support website. For how to download the driver, refer to “Driver problems” in this *User Guide*.
 2. Remove the fingerprint.
 - a. Click **Start** → **Settings** → **Accounts** → **Sign-in options** → **Fingerprint recognition (Windows Hello)**.
 - b. Click **Remove** to remove the fingerprint. No matter how many fingers have been set, you only need to remove once.
 3. Update the fingerprint driver.
 - a. Type **device manager** in the Windows search box.
 - b. Click **Device Manager** from the list of results. The Device Manager window opens.
 - c. Click arrow icon > next to **Biometric devices** to expand the section.

- d. Click the fingerprint driver, right-click, and then click **Update driver**.
 - e. Browse to the folder where the latest fingerprint driver is stored. Double-click to run the driver and then follow the on-screen instructions to update the driver.
 - f. Restart your computer.
4. Enroll the fingerprint again. For how to enroll the fingerprint, refer to fingerprint recognition topic in this *User Guide*.

Note: During the enrollment, it is recommended that you follow the on-screen instructions to enroll the full image of your fingerprint.

If the problem persists, call Lenovo Customer Support Center for help. For a list of the latest Lenovo Support phone numbers for your country or region, go to <https://pcsupport.lenovo.com/supportphonenumberlist>.

Mouse problems

Follow the instructions to troubleshoot the mouse problem.

What should I do when my mouse is not working?

Try the solutions in the order below:

- If there is a power switch on your mouse, ensure that it is turned on.
- If you are using a wireless mouse:
 - Ensure that the battery power is enough for working.
 - If it is connected through a USB dongle, ensure that the USB dongle is connected to a working USB connector of your computer. The USB dongle is usually stored within the battery compartment of the mouse.
 - If it is a Bluetooth mouse, ensure that the Bluetooth connection with your computer is correct. If there is a Bluetooth connection problem, refer to “Bluetooth connection problems” in this *User Guide*.
- If you are using a wired mouse:
 - Connect it to a working USB connector on your computer correctly.
 - If the mouse still does not work, try to connect another wired mouse that works correctly to the same USB connector. If no problem, try the next solution.
- Update the mouse driver, to do this:
 1. Type **device manager** in the Windows search box.
 2. Click **Device Manager** from the list of results. The Device Manager window opens.
 3. Click arrow icon > next to **Mice and other pointing devices** to expand the section.
 4. Right-click the mouse driver, click **Update driver**, and then follow the on-screen instructions to update the driver.









If the problem persists, call Lenovo Customer Support Center for help. For a list of the latest Lenovo Support phone numbers for your country or region, go to <https://pcsupport.lenovo.com/supportphonenumberlist>.

Bluetooth connection problems

Follow the instructions to troubleshoot the Bluetooth connection problem.

Why can't I connect to Bluetooth?

Try the solutions in the order below:









- Ensure that Bluetooth is supported and enabled on both your computer and your Bluetooth device. To turn on Bluetooth on your computer:
 1. Click the quick settings area    on the right side of the taskbar.
 2. In the Bluetooth quick setting, check if Bluetooth is turned on. If not, click the Bluetooth icon to turn it on.
- Restart your Bluetooth device.
- Ensure that your Bluetooth device is charged or has enough power, and is placed within the required Bluetooth connection distance range of your computer.
- Ensure that airplane mode is turned off on your computer. To do this:
 1. Click the quick settings area    on the right side of the taskbar.
 2. In the Airplane mode quick setting, check if Airplane mode is turned off. If not, click the Airplane mode icon to turn it off.
- Ensure your Bluetooth device is not too close to other USB devices that are connected to your computer. Unshielded USB devices might interfere with Bluetooth connections.
- Remove your Bluetooth device, and then add it again. To do this:
 1. Click **Start** → **Settings** → **Bluetooth & devices** → **Devices**.
 2. Click **More options** of the Bluetooth device you are having problem with.
 3. Click **Remove device** → **Yes** to remove the Bluetooth device.
 4. Ensure that the Bluetooth on both your computer and the Bluetooth device are turned on. Ensure that the device is discoverable.
 5. Click the quick settings area    on the right side of the taskbar.
 6. Click **Manage Bluetooth devices** (>) on the Bluetooth quick setting to expand the section.
 7. Click the device when it is displayed on the **New devices** list, and then follow the on-screen instructions.
- Run the Bluetooth troubleshooter. To do this:
 1. Click **Start** → **Settings** → **System** → **Troubleshoot** → **Other troubleshooters**.
 2. Locate the Bluetooth section, click **Run** and then follow the on-screen instructions.
- Uninstall the driver of the Bluetooth adapter. Windows will automatically install the latest driver. To do this:
 1. Type **device manager** in the Windows search box.
 2. Click **Device Manager** from the list of results. The Device Manager window opens.
 3. Click arrow icon > next to **Bluetooth** to expand the section.
 4. Right-click the Bluetooth device you are having problem with, and then click **Uninstall device**.
 5. In the Uninstall Device window, confirm that you want to uninstall this device from your system, and then click **Uninstall**.
 6. After the driver is uninstalled, restart your computer. Windows will automatically install the latest driver.
 7. If Windows does not reinstall the driver automatically, open device manager and click **Action** → **Scan for hardware changes**.

If the problem persists, call Lenovo Customer Support Center for help. For a list of the latest Lenovo Support phone numbers for your country or region, go to <https://pcsupport.lenovo.com/supportphonenumberlist>.

Wi-Fi connection problems

Follow the instructions to troubleshoot Wi-Fi connection problem.

What should I do when I cannot connect to Wi-Fi ?

- Visit a different website to check if there is a problem with a specific website.
- Ensure that Wi-Fi is turned on and Airplane mode is turned off. To do this:
 1. Click the quick settings area    on the right side of the taskbar.
 2. Check if Wi-Fi is turned on. If not, click the Wi-Fi icon to turn it on.
 3. Check if Airplane mode is turned off. If not, click the Airplane mode icon to turn it off.
- Reconnect to Wi-Fi. To do this:
 1. Click the quick settings area    on the right side of the taskbar.
 2. Click **Manage Wi-Fi connections** (>) on the Wi-Fi quick setting to expand the section.
 3. Click the Wi-Fi network you connected before, and click **Disconnect**.
 4. Wait a moment, and then click **Connect**.
- Connect to the network with a different frequency band. Most Wi-Fi routers support both 2.4 GHz and 5 GHz network frequency bands. They appear as two different networks in the list of Wi-Fi networks. If your list of Wi-Fi networks includes these two networks, connect to the one with different frequency band.
- Run the network troubleshooter on your computer to diagnose and solve common network connecting problems. To do this:
 1. Right-click the network icon in the quick settings area    on the right side of the taskbar.
 2. Click **Diagnose network problems** and follow on-screen instructions.
- Restart your modem and wireless router. To do this:
 1. Disconnect your modem and wireless router from power source.
 2. If your modem has a backup battery, remove the battery.
 3. Wait for at least 30 seconds.
 4. If you had removed the backup battery from the modem, install it.
 5. Connect your modem and wireless router to the power source.
 6. Connect to Wi-Fi network on your computer again.
- Disable your wireless network adapter driver and enable it again. To do this:
 1. Type **device manager** in the Windows search box.
 2. Click **Device Manager** from the list of results. The Device Manager window opens.
 3. Click arrow icon > next to **Network adapters** to expand the section.
 4. Right-click the wireless network adapter driver, and then click **Disable device**.
 5. Click **Yes** in the window prompted. The wireless network reader driver is disabled.
 6. Right-click the wireless network adapter driver again, and then click **Enable device** to enable the driver.
- Uninstall your wireless network adapter driver and restart your computer. To do this:
 1. Before uninstalling, download the available driver on a different computer from Lenovo support website and save it to a USB flash drive. For how to download the driver, see “Driver problems” in this *User Guide*.

2. Type **device manager** in the Windows search box.
 3. Click **Device Manager** from the list of results. The Device Manager window opens.
 4. Click arrow icon > next to **Network adapters** to expand the section.
 5. Right-click the wireless network adapter driver, and then click **Uninstall device**.
 6. In the Uninstall Device window, confirm that you want to uninstall this device from your system, and then click **Uninstall**.
 7. After the driver is uninstalled, restart your computer.
 8. Install the driver you have downloaded.
- Contact your Internet service provider to check if there are any issues with your internet plan or connection.

If the problem persists, call Lenovo Customer Support Center for help. For a list of the latest Lenovo Support phone numbers for your country or region, go to <https://pcsupport.lenovo.com/supportphonenumberlist>.

Pen problems

Follow the instructions to troubleshoot the corresponding pen problems.

What should I do if the pen is not detected or responded?

Follow the instructions to troubleshoot your pen problems.

1. Check if the pen is in low power by tapping the pen to the screen.
2. Charge the pen if the screen does not have response.
3. Re-tap the pen on the screen to check whether it works after the pen has been charged for a while.

Note: The charging time might vary depending on pen types.

4. Check if the pen has properly established Bluetooth connection with your computer if the pen supports Bluetooth.
 - a. Click the quick settings area  on the right side of taskbar.
 - b. Click the Bluetooth settings and turn on the Bluetooth.
 - c. Select the pen in the list displayed and follow on-screen instructions.
5. Update the driver by updating **Lenovo Pen Settings**, an app preinstalled on your computer, if the pen cannot establish Bluetooth connection with your computer.
6. Try step 4 again to establish Bluetooth connection with your computer.

If the problem persists, call Lenovo Customer Support Center for help. For a list of the latest Lenovo Support phone numbers for your country or region, go to <https://pcsupport.lenovo.com/supportphonenumberlist>.

Startup problems

Follow the instructions to troubleshoot the corresponding startup problems.

What should I do if my computer does not start up?

Try the following steps:

1. Ensure that the power adapter is connected to your computer and the power cord of your computer is plugged into a working electrical outlet.
2. If you are using a power strip or surge protector, ensure it is turned on and working.

3. Press the power button to turn on your computer again.

What should I do if I cannot log in to Windows?

Try the following solutions:

- Restart your computer. The startup process might be interrupted abnormally. Restart to see if your computer can start up normally:
 1. Shut down your computer by pressing the power button for 10 seconds until the screen turns off.
 2. Wait about 1 minute. Then, press the power button to turn on your computer again.
- Set the drive that the operating system has been installed on as the first boot device. Then, restart your computer. For details, refer to the BIOS related information in this *User Guide*.
- Recover your Windows operating system. Depending on your specific situation, you can choose from different Windows recovery options. For details, go to https://support.microsoft.com/windows_recovery
- Recover and restore the UEFI BIOS from the last uncorrupted and secure backup. Then, restart your computer. For details, refer to “UEFI BIOS problems” in this *User Guide*.
- Reset the UEFI BIOS to factory default settings. Then, restart your computer. For details, refer to “BIOS problems” in this *User Guide*.

If the problem persists, call Lenovo Customer Support Center for help. For a list of the latest Lenovo Support phone numbers for your country or region, go to <https://pcsupport.lenovo.com/supportphonenumberlist>.

What should I do if I encounter a blue screen during the startup?

Try the following solutions:

- Fix STOP code errors:

For details, go to https://support.microsoft.com/stop_code_error.
- Update Windows:
 1. Restart your computer in safe mode. For details, go to https://support.microsoft.com/safe_mode.
 2. Get the latest updates from the Windows Update. For details, go to https://support.microsoft.com/windows_update.
 3. Restart your computer.

If the problem persists, call Lenovo Customer Center for help. For a list of the latest Lenovo Support phone numbers for your country or region, go to <https://pcsupport.lenovo.com/supportphonenumberlist>.

Password problems

Follow the instructions to troubleshoot the corresponding password problems.

How to change my Windows password?

Follow below instructions to change your Windows password.

1. Type **Sign-in options** in the Windows search box and press Enter.
2. Select **Password** → **Change** and follow on-screen instructions to change the password.

How to reset my Windows password?

Follow below instructions to reset your Windows password.

- Do the following if you have set security questions.
 1. Click **Reset password** on the sign-in screen after you have entered an incorrect password.

Note: Contact your administrator if you do not see an option to reset your password.
 2. Follow on-screen instructions to reset a new password.
- Do the following if you have created a password reset disk.
 1. Connect a password reset disk to a USB-compatible connector on your computer.
 2. Follow on-screen instructions to reset your password.
- Do the following if you have an administrator account.
 1. Sign in to your computer with the local administrator account.
 2. Follow on-screen instructions to reset your password.

How to find your BitLocker recovery key in Windows?

Follow below instructions to find my BitLocker recovery key in Windows.

- In your Microsoft account:
 1. Open a web browser on any device such as mobile phone with internet access.
 2. Sign into your Microsoft account at <https://account.microsoft.com/devices/recoverykey>.
 3. Follow on-screen instructions to find the recovery key.
- On a printed paper:

Find out the paper with the record of BitLocker recovery information if you have printed or recorded the recovery key on the paper.
- On a USB flash drive:
 1. Connect the USB flash drive into a USB-compatible connector on your computer.
 2. Follow the on-screen instructions to find the recovery key.
- By your administrator:

Contact your administrator to have the recovery key if your computer is connected to a domain or signed into an organization using a work or school e-mail account.

For more details, go to <https://support.microsoft.com/windows/finding-your-bitlocker-recovery-key-in-windows>.

If the problem persists, call Lenovo Customer Support Center for help. For a list of the latest Lenovo Support phone numbers for your country or region, go to <https://pcsupport.lenovo.com/supportphonenumberlist>.

Performance problems

Follow the instructions to troubleshoot the corresponding performance problems.

What should I do if my computer stops responding?

Try the following solutions:

- Wait several seconds to see if it responds properly later.
- Terminate tasks that are not responding.
- Restart your computer.
 - Restart in Windows
 1. Press Ctrl+Alt+Delete at the same time.

2. Click power icon  , then select **Restart**.
- Shut down and turn on the computer again
 1. Shut down your computer by pressing the power button for 10 seconds until the screen turns off.
 2. Wait about 1 minute. Then, press the power button to turn on your computer again.

What should I do if my computer responds slowly?

Try the following solutions:

- Restart your computer.
- Cool down your computer.

Turn off your computer, move it to a cooler place, and let it cool down for at least five minutes.
- Clean up disks in Windows.

Delete temporary files and free up more drive space on your computer using Disk Cleanup. For details, go to https://support.microsoft.com/disk_cleanup.
- Remove unnecessary programs from the startup programs.
 1. Open the **Start** menu, and then click **Settings → Apps → Startup**.
 2. In the **Startup** section, turn off the switch of programs that are not necessary to start automatically when you log in to Windows.
- Uninstall unnecessary software.
- Scan for viruses and Malware using the anti-virus software that is installed on your computer.
- Change to another power mode with higher performance. For details, go to https://support.microsoft.com/change_the_power_mode_for_your_windows_pc.
- Repair missing or corrupted system files using the System File Checker tool. For details, go to https://support.microsoft.com/system_file_checker.
- Update Windows.

Get the latest updates from the Windows Update. For details, go to https://support.microsoft.com/windows_update.
- Update drivers.

You can update drivers manually. For details, refer to “Driver problems” in this *User Guide*.
- Recover your Windows operating system.

Depending on your specific situation, you can choose from different recovery options. For details, go to https://support.microsoft.com/windows_recovery.
- Use memory module(s) with higher speed.

If the problem persists, call Lenovo Customer Center for help. For a list of the latest Lenovo Support phone numbers for your country or region, go to <https://pcsupport.lenovo.com/supportphonenumber>.

Power charging problems

Follow the instructions to troubleshoot the corresponding power charging problems.

What should I do if my computer is connected to ac power but not charged?

Try the solutions in the order below.

1. Ensure that you use Lenovo-certified ac power adapter and power cord that are designed for charging with proper wattage. If there are any visible signs of damage, you can purchase a new ac power adapter or power cord at <https://www.lenovo.com/accessories>.
2. Ensure that the power adapter and power cord are completely and firmly connected to both your computer and a working power outlet.
3. Ensure that the power connector is clean and well-conditioned.
4. Turn off the computer and disconnect the computer from ac power and all connected cables. Wait a few minutes. Then, reconnect to ac power and turn on the computer.

If the problem persists, call Lenovo Customer Support Center for help. For a list of the latest Lenovo Support phone numbers for your country or region, go to <https://pcsupport.lenovo.com/supportphonenumberlist>.

What should I do if the built-in battery cannot be charged?

Try the solutions in the order below.

1. Ensure that you use the power adapter with proper wattage. Low-wattage power adapters might cause battery charging problem.
2. Exit any heavy-loading programs and charge the computer again. To check the load of programs in process: Press Ctrl+Alt+Delete, and then click **Task Manager** → **Processes**.
3. Move your computer to a cool and well-ventilated spot. Battery charging is also affected by its temperature.
4. Reset the battery gauge. To do this:
 - a. Open the Vantage app, and then click the menu icon at the top-right corner.
 - b. Select **Power** → **BATTERY SETTINGS**, and then click **RESET** in **Battery gauge reset** section.
5. Update the UEFI BIOS to the latest version. For details, refer to “UEFI BIOS problems” in this *User Guide*.

If the problem persists, you might need to replace the battery. For details, call Lenovo Customer Support Center for help. For a list of the latest Lenovo Support phone numbers for your country or region, go to <https://pcsupport.lenovo.com/supportphonenumberlist>.

What should I do if the built-in battery is not fully charged?

Keeping the battery from full charge when battery power is not in heavy use can help extend its lifespan.

If you want to fully charge the battery, try the solutions in the order below.

1. Disable the Smart Charge. To do this:
 - a. Open the Vantage app, and then click the menu icon at the top-right corner.
 - b. Select **Power** → **BATTERY SETTINGS**, and then slide the **Smart charge** switch to disable the function.
2. Reset the battery gauge. To do this:
 - a. Open the Vantage app, and then click the menu icon at the top-right corner.
 - b. Select **Power** → **BATTERY SETTINGS**, and then click **RESET** in **Battery gauge reset** section.
3. Update the UEFI BIOS to the latest version. For details, refer to “UEFI BIOS problems” in this *User Guide*.

If the problem persists, call Lenovo Customer Support Center for help. For a list of the latest Lenovo Support phone numbers for your country or region, go to <https://pcsupport.lenovo.com/supportphonenumberlist>.

Docking station problems

Follow the instructions to troubleshoot the corresponding docking station problems.

What should I do if the docking station has a poor connection?

Try the solutions in the order below.

1. Ensure that your computer is compatible with the docking station. To check the compatibility, go to <https://www.lenovo.com/accessoriesguide>.
2. Use a dry, soft, and lint-free cloth or a piece of absorbent cotton to remove dust from the connectors on the docking station.
3. Use the cable that comes with your computer or the docking station, and ensure it is completely and firmly connected to both devices. If there are any visible signs of damage, you can purchase a new cable at <https://www.lenovo.com/accessories>.

Note: If your docking station has a LED indicator, check if it turns to solid white. If not, disconnect the cable and wait 15 seconds. Then, reconnect it to the docking station.

4. Restart your computer to establish a new connection to the docking station.

If the problem persists, call Lenovo Customer Support Center for help. For a list of the latest Lenovo Support phone numbers for your country or region, go to <https://pcsupport.lenovo.com/supportphonenumber>.

What should I do if the docking station is well connected but does not work?

Try the solutions in the order below.

1. Update the driver to the latest version. For details, refer to “Driver problems” in this *User Guide*.
2. Update the firmware. To do this:
 - a. Go to <https://pcsupport.lenovo.com> and search by your docking station name.
 - b. Select and download the update package you want under **Drivers and Software** or **Drivers and Firmware** tab.
 - c. Follow the on-screen instructions to manually install the firmware.

Note: The firmware packages might not be available depending on the docking station.

3. Update the UEFI BIOS to the latest version. For details, refer to “UEFI BIOS problems” in this *User Guide*.

If the problem persists, call Lenovo Customer Support Center for help. For a list of the latest Lenovo Support phone numbers for your country or region, go to <https://pcsupport.lenovo.com/supportphonenumber>.

Hinge problems

Follow the instructions to troubleshoot the corresponding hinge problems.

What should I do if the computer hinges lose torque or I cannot open/close the computer?

The screws of hinges might be loose, or the hinges might be broken.

To solve the problem, you can go to a service center in your area for professional support. To locate the nearest service center, go to <https://support.lenovo.com/partnerlocator>.

Touchpad/trackpad problems

Follow the instructions to troubleshoot the corresponding touchpad/trackpad problems.

What should I do if my touchpad/trackpad is not responding?

If your touchpad/trackpad is not responding, it might be because you have disabled the touchpad/trackpad or your touchpad/trackpad driver is out-of-date or malfunctioning. To solve the problem, you can try the following solutions.

- Enable the touchpad:

1. Go to **Start → Settings → Bluetooth & devices → Touchpad**.
2. Turn on the **Touchpad** toggle.

Note: For some Lenovo computers, you can also press the hotkey marked with  or the key combination Fn+M to enable or disable the touchpad.

- Update the touchpad driver:

1. Type **Device Manager** in the Windows search box and then press Enter.
2. Click the arrow icon > next to **Human Interface Devices** to expand the section.
3. Right-click the touchpad, select **Update driver**, and follow the on-screen instructions.

- If a touchpad/trackpad problem occurs after a recent driver update, follow the instructions below to roll back to the previously installed driver:

1. Type **Device Manager** in the Windows search box and then press Enter.
2. Click the arrow icon > next to **Human Interface Devices** to expand the section.
3. Right-click the touchpad, and select **Properties**.
4. Under **Driver**, select **Roll Back Driver** and follow the on-screen instructions.

If the problem persists, call Lenovo Customer Support Center for help. For a list of the latest Lenovo Support phone numbers for your country or region, go to <https://pcsupport.lenovo.com/supportphonenumber>.

What should I do if the touchpad/trackpad response is very slow?

Go to **Start → Settings → Bluetooth & devices → Touchpad**. Then, adjust the cursor speed and the touchpad sensitivity.

If the problem persists, call Lenovo Customer Support Center for help. For a list of the latest Lenovo Support phone numbers for your country or region, go to <https://pcsupport.lenovo.com/supportphonenumber>.

Touch screen problems

Follow the instructions to troubleshoot the corresponding touch screen problems.

Why does my touch screen not respond?

It could be caused by the following two reasons.

- Your touch screen is not yet enabled. To enable the touch screen, do the following:

1. Type **device manager** in the Windows search box and then press Enter.
2. Under **Human Interface Devices**, select **HID-compliant touch screen**.
3. Select the **Driver** tab, select **Enable device**, and then confirm.

Note: If there's more than one HID-compliant touch screen device listed, perform steps 2–3 for each device.

- Your touch screen driver needs to be updated. To update the touch screen driver, do the following:
 1. Type **device manager** in the Windows search box and then press Enter.
 2. Under **Human Interface Devices**, select **HID-compliant touch screen**.
 3. Select the **Driver** tab and then select **Update Driver**.
 4. Select **Search automatically for drivers** and then follow the on-screen instructions to confirm the best available driver is installed.

Note: If there's more than one HID-compliant touch screen device listed, perform steps 2–4 for each device.

Audio problems

Follow the instructions to troubleshoot the corresponding audio problems.

What should I do if the audio is not working?

If you encounter any audio problems, such as no audio or malfunctioning audio, you can try the following solutions to troubleshoot and fix the problems:

- Verify your audio settings:
 1. Go to **Start → Settings → System → Sound**.
 2. Verify that the sound output and input devices are selected correctly.

Note: If you are using an external audio device, ensure that the device is properly connected to your computer.
 3. Verify that the volume is properly set and your computer is not muted.
- Run the audio troubleshooter:
 1. Go to **Start → Settings → System → Sound**.
 2. Under **Advanced**, find **Troubleshoot common sound problems**, and click **Output devices** or **Input devices** to troubleshoot and fix the problem.

For more solutions to audio problems, go to <https://support.lenovo.com/solutions/ht501860>.

If the problem persists, call Lenovo Customer Support Center for help. For a list of the latest Lenovo Support phone numbers for your country or region, go to <https://pcsupport.lenovo.com/supportphonenumber>.

Display problems

Follow the instructions to troubleshoot the corresponding display problems.

How to troubleshoot blue screen errors?

Blue screen errors can occur if a serious problem causes Windows to shut down or restart unexpectedly.

You can try the Blue Screen Troubleshooter in the Get Help app.

1. Type **Get Help** in the Windows search box and then press Enter.
2. In the search box of the Get Help app, type **Troubleshoot BSOD error**.
3. Follow the guided walkthrough.

How to troubleshoot black screen issues?

Black screen issues could be caused by the following two reasons.

- Your Windows needs to be updated. To update the Windows:
 1. Press the Windows logo key+Ctrl+Shift+B to wake your computer from the black screen.
 2. Select the Start menu on the taskbar and then select **Settings**.
 3. Select **Windows Updates** and then select **Check for updates**. If updates are available, download and install them.
- Your mouse and keyboard drivers need to be updated. To update the mouse and keyboard drivers:
 1. Press the Windows logo key+Ctrl+Shift+B to wake your computer from the black screen.
 2. Type **device manager** in the Windows search box and then press Enter.
 3. Under **Keyboards**, select **HID Keyboard Device**.
 4. Select the **Power Management** tab and then check **Allow this device to wake the computer**.
 5. Under **Keyboards**, select **HID Keyboard Device**, and then select **Update driver**.
 6. Select **Search automatically for drivers** and then follow the on-screen instructions to confirm the best available driver is installed.

Note: If there is more than one HID Keyboard Device listed, perform Steps 3–6 for each device.

 7. Repeat Steps 3–6 for **Mice and other pointing devices**.

Note: If there is more than one HID-compliant mouse device listed, perform Steps 3–6 for each device.

If your screen is still black after using shortcuts Windows logo key+Ctrl+Shift+B or restarting your computer, call Lenovo Customer Center for help. For a list of the latest Lenovo Support phone numbers for your country or region, go to <https://pcsupport.lenovo.com/supportphonenumberlist>.

How to troubleshoot screen flickering?

Screen flickering is usually caused by a display driver issue or an incompatible app.

To determine whether the display driver or app causes the problem, check to see if Task Manager flickers. To open Task Manager, press Ctrl+Alt+Delete or Ctrl+Shift+Esc.

- If Task Manager also flickers, the display driver is probably causing the problem. In this scenario, roll back your display driver:
 1. Type **device manager** in the Windows search box and then press Enter.
 2. Under **Display adapters**, select a display adapter.
 3. Select the **Driver** tab and then select **Roll Back Driver**.
 4. Click **Yes** to roll back your display driver and restart your computer.

Note: If the **Roll Back Driver** option is unavailable, Windows does not have a previous driver to roll back to. In this scenario, you can try updating or uninstalling your display driver in the **Driver** tab.
- If Task Manager does not flicker, an incompatible app is probably causing the problem. In this scenario, update or uninstall an incompatible app:
 1. Check if any app needs to be updated from the Microsoft Store or the manufacturer's site.
 2. If step 1 does not work, uninstall the app:
 - a. Select the Start menu on the taskbar and then select **Settings**.
 - b. Select **Apps** → **Installed apps**.

- c. Scroll down the list, find the app you want to uninstall, and then select **Uninstall**.
- d. In the popup window, select **Uninstall**.
- e. If you're asked to confirm your choice, select **Yes**.

Note: Check in the recently used app if screen flickering usually occurs in a specific app. If yes, prioritize uninstalling that app.

After uninstalling an app, restart your computer and check if the screen flickering issue is resolved. If the issue retains, uninstall each app one by one until the issue is resolved.

What should I do if the external monitor stops working?

If the external monitor connected to your computer suddenly stops working and reconnecting it to your computer does not help, you can try the following solutions.

- Update the display driver :
 1. Type **Device Manager** in the Windows search box, and then press Enter.
 2. Click the arrow icon > next to **Display adapters** to expand the section.
 3. Right-click your display adapter, select **Update driver**, and follow the on-screen instructions.
- If a display problem occurs after a recent driver update, roll back to the previously installed driver:
 1. Type **Device Manager** in the Windows search box and then press Enter.
 2. Click the arrow icon > next to **Display adapters** to expand the section.
 3. Right-click the display driver, and select **Properties**.
 4. Under **Driver**, select **Roll Back Driver** and follow the on-screen instructions.

If the problem persists, call Lenovo Customer Support Center for help. For a list of the latest Lenovo Support phone numbers for your country or region, go to <https://pcsupport.lenovo.com/supportphonenumberlist>.

What should I do if the display remains dim?

Try the following methods to increase the display brightness:

- Press the hotkey **Fn**+ to increase the display brightness.
- Go to **Start** → **Settings** → **System** → **Display**, and move the **Brightness** slider to the right.
- Click the quick settings area  on the right side of the taskbar to open the quick settings panel, and then move the **Brightness** slider to the right.

If none of those methods work, you can try to fix the display driver. For details, refer to “What should I do if the external monitor stops working” in this *User Guide*.

If the problem persists, call Lenovo Customer Support Center for help. For a list of the latest Lenovo Support phone numbers for your country or region, go to <https://pcsupport.lenovo.com/supportphonenumberlist>.

Fan problems

Follow the instructions to troubleshoot the corresponding fan problems.

What should I do if the fan makes abnormal noise?

1. Check running applications or background processes. You can type **task manager** in the Windows search box and press Enter. Then, terminate power-consuming applications or processes that are not in use to reduce fan noises.

2. Check your computer operation mode. The noise might be caused by high fan speed. You can adjust your computer operation mode to the proper one:
 - For computer models with the intelligent cooling feature, power efficiency mode or balanced mode is preferred. For details, see “Intelligent cooling” in this *User Guide*.
 - For computer models with the system operation modes feature, power saving (quiet) mode or auto (balanced) mode is preferred. For details, see “System operation modes” in this *User Guide*.
3. Check if your operating system and device drivers are the latest version. Outdated operating system or device drivers might cause fan overload, resulting in the abnormal noise. You can update the operating system or device drivers to the latest version. For details, see “OS problems” or “Driver problems” in this *User Guide*.
4. If the problem persists, call Lenovo Customer Support Center for help. For a list of the latest Lenovo Support phone numbers for your country or region, go to <https://pcsupport.lenovo.com/supportphonenumberlist>.

What should I do if my computer is overheating?

1. Improve airflow. Ensure that the vents of your computer are not covered and there is enough airflow to keep the computer cool. Avoid using the computer on a soft surface, such as a bed or couch. It is recommended to use the computer on a table or lap desk in a cool room.
2. Check your computer operation mode. The overheat might be caused by high computer performance. You can adjust your computer operation mode to the proper one:
 - For computer models with the intelligent cooling feature, power efficiency mode or balanced mode is preferred. For details, see “Intelligent cooling” in this *User Guide*.
 - For computer models with the system operation modes feature, power saving (quiet) mode or auto (balanced) mode is preferred. For details, see “System operation modes” in this *User Guide*.
3. Check running applications or background processes. You can type **Task Manager** in the Windows search box and press Enter. Then, terminate power-consuming applications or processes that are not in use to reduce heat.
4. If the problem persists, call Lenovo Customer Support Center for help. For a list of the latest Lenovo Support phone numbers for your country or region, go to <https://pcsupport.lenovo.com/supportphonenumberlist>.

OS problems

Follow the instructions to troubleshoot the corresponding windows system problems.

How to install a Windows operating system?

You can install a Windows operating system to fix issues like slow system operation, frequent system crash, virus infection, insufficient disk space, and so on. Follow the instructions to install a Windows operating system to return your computer to a cleaner state.

Microsoft® constantly makes updates to the Windows operating system. Before installing a particular Windows version, check the compatibility list and the minimum system requirements for the Windows version. For details, go to <https://support.lenovo.com/solutions/ht512575>.

Attention:

- It is recommended that you update your operating system through official channels. Any unofficial update might cause security risks.
- The process of installing a new operating system deletes all the data on your internal storage drive, including the data stored in a hidden folder.
- Before installing or upgrading a particular Windows version, make a backup copy of all the data that you want to keep.

Prerequisite

1. For models with a Trusted Platform Module, if you are using the Windows BitLocker® Drive Encryption feature, ensure that you have disabled the feature. You can re-enable the feature after the operating system installation is complete.
2. Ensure that the security-related features (Security Chip, Virtualization, and Secure Boot) are enabled.
To access the security-related features in the UEFI BIOS menu:
 - a. Restart the computer. When the logo screen is displayed, do one of the following to enter the UEFI BIOS menu depending on your computer model:
 - For ThinkPad and ThinkBook computers: Press F1.
 - For Yoga and IdeaPad computers: Press F2.
 - b. Select **Security** and select the security-related features. Then, press Enter. Ensure that the security-related features are enabled.
 - c. Press F10 to save the settings and exit.
3. Network connection and ac power connection are required during the whole process.

Install a Windows operating system

1. Connect the drive that contains the operating system installation program to the computer.
To create the installation media, refer to <https://support.microsoft.com/windows>.
2. Restart the computer. When the logo screen is displayed, do one of the following to enter the UEFI BIOS menu depending on your computer model:
 - For ThinkPad and ThinkBook computers: Press F1.
 - For Yoga and IdeaPad computers: Press F2.
3. Do one of the following depending on your computer model:
 - For ThinkPad computers: Select **Startup** → **Boot** to open the **Boot Priority Order** submenu.
 - For ThinkBook, Yoga, and IdeaPad computers: Select **Boot**.
4. Change the startup sequence:
 - a. Select the drive that contains the operating system installation program. Do one of the following depending on your computer model:
 - For ThinkPad computers: Such as **USB HDD**. Then, press Esc.
 - For ThinkBook, Yoga, and IdeaPad computers: Such as **USB Boot**. Then, press Esc.
 - b. Press F10 to save the setting and exit.

Attention: After you change the startup sequence, ensure that you select the correct device during a copy, save, or format operation. If you select the wrong device, the data on that device might be erased or overwritten.

Note: If the system cannot boot from the selected drive, disable **Secure Boot** and try again. Ensure that you re-enable the feature after the operating system installation is complete.
5. Follow the on-screen instructions to install the device drivers and necessary programs.

What should I do if the process of installation fails?

1. Read the error message to figure out the specific cause.
2. Check if the installation media works well.
3. Check if BIOS settings are correct and ensure that UEFI BIOS on your device is up-to-date.
4. Check if the available disk space of your computer meets the requirement of the new Windows version.

5. Check antivirus and firewall settings: If you had antivirus software or a firewall installed on the previous system, these features might interfere with the system installation. Temporarily disable the antivirus functionality within the BIOS before attempting system installation.
6. Reinstall the Windows system.
7. If the problem persists, call Lenovo Customer Support Center for help. For a list of the latest Lenovo Support phone numbers for your country or region, go to <https://pcsupport.lenovo.com/supportphonenumberlist>.

How to upgrade a Windows operating system?

You can upgrade your Windows operating system for better performance on security enhancement, new feature experience, and so on. Follow the instructions to upgrade a Windows operating system.

Attention:

- Microsoft constantly makes updates to the Windows operating system. Before upgrading a particular Windows version, check the compatibility list and the minimum system requirements for the Windows version. For details, go to <https://support.lenovo.com/solutions/ht512575>.
- It is recommended that you upgrade your operating system through official channels. Any unofficial update might cause security risks.
- Before upgrading a particular Windows version, make a backup copy of all the data that you want to keep.

Prerequisite

1. For models with a Trusted Platform Module, if you are using the Windows BitLocker® Drive Encryption feature, ensure that you have disabled the feature. You can re-enable the feature after the operating system installation is complete.
2. Ensure that the security-related features (Security Chip, Virtualization, and Secure Boot) are enabled.
To access the security-related features in the UEFI BIOS menu:
 - a. Restart the computer. When the logo screen is displayed, do one of the following to enter the UEFI BIOS menu depending on your computer model:
 - For ThinkPad and ThinkBook computers: Press F1.
 - For Yoga and IdeaPad computers: Press F2.
 - b. Select **Security** and select the security-related features. Then, press Enter. Ensure that the security-related features are enabled.
 - c. Press F10 to save the settings and exit.
3. Network connection and ac power connection are required during the whole process.

Upgrade a Windows operating system

1. Type **Windows Update** in the Windows search box and press Enter.
2. Click **Check for updates**. If an operating system update package is available, it will be automatically downloaded and installed.
3. Follow the on-screen instructions to install the device drivers and necessary programs.

What should I do if the process of upgrading fails?

1. Read the error message to figure out the specific cause.
2. Check if BIOS settings are correct and ensure that UEFI BIOS on your device is up-to-date.
3. Check if the available disk space of your computer meets the requirement of the new Windows version.
4. Upgrade the system again.

- If the problem persists, call Lenovo Customer Support Center for help. For a list of the latest Lenovo Support phone numbers for your country or region, go to <https://pcsupport.lenovo.com/supportphonenumberlist>.

How to recover my Windows operating system?

When you encounter some unexpected issues with your operating system, you can choose to recover your operating system by yourself or call Lenovo Customer Support Center.

Microsoft constantly makes updates to the Windows operating system. Before installing a particular Windows version, check the compatibility list and the minimum system requirements for the Windows version. For details, go to <https://support.lenovo.com/solutions/ht512575>.

Recovery options

- **Reset system to factory default:**

Refer to the instructions in <https://support.lenovo.com/HowToCreateLenovoRecovery>.

- **Other recovery options like restore system to a previous system point:**

Refer to the instructions in Popular Topics: <https://support.lenovo.com/solutions/ht118590>.

Here are some frequently-asked cases and solutions for your reference:

Cases	Solutions
Your PC is not working well and you recently installed a device from Windows Update.	Remove the installed update device.
Your PC isn't working well and it's been a while since you installed an app or changed system settings.	Reset your system.
Your PC will not start or is still loading.	Use the Startup Repair function.
Your PC will not start, you haven't created a recovery drive, and resetting your PC didn't work.	Use installation media to reinstall Windows OS.
Your PC will not start and you haven't created a recovery drive.	Use installation media to restore your PC.
Your PC will not start and you've created a recovery drive.	Use a recovery drive to restore or recover your PC.
You want to reinstall your previous operating system.	Go back to your previous version of Windows.
Your PC is not working well and you recently installed an app.	Restore from a system restore point.
You suspect your device has been infected.	Use installation media to reinstall Windows OS.

What should I do if the process of recovery fails?

1. Read the error message to figure out the specific cause.
2. Check if network and ac power source are connected.
3. Check if the installation media works well.
4. Check if BIOS settings are correct and ensure that UEFI BIOS on your device is up-to-date.
5. Check if the available disk space of your computer meets the requirement of the new Windows version.
6. Reinstall the Windows system.
7. If the problem persists, call Lenovo Customer Support Center for help. For a list of the latest Lenovo Support phone numbers for your country or region, go to <https://pcsupport.lenovo.com/supportphonenumberlist>.

Driver problems

Follow the instructions to troubleshoot the corresponding driver problems.

How to update or install the latest device driver?

You should download the latest driver for a component when you notice poor performance from that component or when you install a new component. Updating or installing the latest driver might eliminate problems caused by driver.

Attention:

- It is recommended to download Lenovo-qualified drivers from Lenovo Support Web site. Before downloading, check if it is compatible with your computer. Ensure that the driver you download matches your computer and system version to avoid compatibility issues.
- Before updating or installing a driver, it is recommended to make a backup copy of all the essential data to avoid data loss. Especially for drivers like graphic card, sound card, network card, and so on, which can potentially affect the stability and the performance of your computer.
- Keep your computer connected to the network during the process of updating or installing a driver.
- When the process of update or installation is complete, restart your computer. The new driver will take effect then.

Update and install the latest driver by one of the following methods:

- **From the Lenovo Support Web site:**
 1. Go to <https://pcsupport.lenovo.com> and type the product name or the serial number of your computer into the search box and select your product from the dropdown list.
 2. Click **Drivers & Software**. Click **Select Drivers** under the **Manual Update** tab. Select and download the update package you want.
 3. Follow the instruction at <https://support.lenovo.com/solutions/HT074189> to manually install the driver.
- **From the Windows Update:**
 1. Type **Windows Update** in the Windows search box and press Enter.
 2. Click **Check for Updates**. If an update package is available, it will be automatically downloaded and installed.
- **From the Vantage app:**

Note: Ensure that the application is up to date for the best features and performance.

1. Open the Vantage app, and then click **Device → System Update → CHECK FOR UPDATES**.
2. If an update package is available, follow the on-screen instructions to download and install the package.

Tips for driver installation errors or failures

When you encounter some unexpected errors or failures during the driver installation process, refer to the following frequently-asked cases and solutions.

- Find general solutions, go to <https://support.lenovo.com/solutions/HT105331>
- Find more tips, go to <https://www.lenovo.com/tips>.

Cases	Solutions
The device cannot be recognized by the system.	<ol style="list-style-type: none"> 1. Check if the driver you just installed matches your computer and system version in Lenovo Support Web site. 2. Restart your computer. 3. If the issue still exists, reinstall the driver: <ol style="list-style-type: none"> a. Type device manager in the Windows search box. b. Click Device Manager from the list of results. The Device Manager window opens. c. Right-click the device you are having problem with. Then, select Uninstall device. d. After the driver is uninstalled, restart your computer. Windows will automatically install the latest driver.
An error message is displayed.	<ol style="list-style-type: none"> 1. Read the error message to figure out the specific cause. 2. Download the appropriate driver version from Lenovo support Web site according to the error message. 3. Reinstall the driver.
There is an exception in Device Manager.	<ol style="list-style-type: none"> 1. Reinstall the driver. 2. If the exception still exists, roll back to the previously installed driver.
There are some system stability issues, for example: <ul style="list-style-type: none"> • The system frequently crashes. • Blue Screen of Death occurs. 	For detailed operations, refer to the “Display problems” in this <i>User Guide</i> .
Performance degradation	For detailed operations, refer to the “Performance problems” in this <i>User Guide</i> .
The installation progress is stuck.	<ol style="list-style-type: none"> 1. Restart your computer. For detailed operations, refer to the “Performance problems” in this <i>User Guide</i>. 2. Reinstall the driver.

If the problem persists, call Lenovo Customer Support Center for help. For a list of the latest Lenovo Support phone numbers for your country or region, go to <https://pcsupport.lenovo.com/supportphonenumberlist>.

UEFI BIOS problems

Follow the instructions to troubleshoot the corresponding UEFI BIOS problems.

How to update the UEFI BIOS?

When you install a new program, device driver, or hardware component, you might need to update the UEFI BIOS.

Download and install the latest UEFI BIOS update package by one of the following methods:

Note: During the UEFI BIOS update process, MRC change might cause memory retraining. Memory retraining is a process to initialize the memory module and run diagnostic tests for the memory module in

your computer. When memory retraining occurs, the screen might be blank. For some computer models, you might see the LED indicators on Esc, F1, and F4 blinking sequentially to indicate the progress. **Do not press the power button to interrupt the process.** Wait a few minutes until the logo screen is displayed.

- From the Lenovo Support Web site:
 1. Go to <https://pcsupport.lenovo.com> and search by your product name.
 2. Click **Drivers & Software** → **Select Drivers** under **Manual Update** tab → **BIOS/UEFI**.
 3. Follow the on-screen instructions to download and install the latest UEFI BIOS update package.
- From the Windows Update:
 1. Type **Windows update** in the Windows search box and press Enter.
 2. Click **Check for updates**.
 3. If a UEFI BIOS update package is available, follow the on-screen instructions to download and install the package.
- From the Vantage app (for some computer models):
 1. Open the Vantage app, and then click **Device** → **System Update** → **CHECK FOR UPDATES**.
 2. If the latest UEFI BIOS update package is available, follow the on-screen instructions to download and install the package.

How to recover the UEFI BIOS?

If the UEFI BIOS is corrupted or maliciously attacked, the UEFI BIOS will automatically recover from the last uncorrupted and secure backup to protect your computer data.

During the UEFI BIOS auto-recovery, the screen will go blank. Do not press the power button to interrupt the progress. Wait a few minutes until the logo screen is displayed.

Note: For some computer models, you can check the progress based on blinking modes of the LED indicators on Esc, F1, and F4. For details, refer to the following table.

Blinking modes	Self-recovery progress
LED indicator on Esc blinks	0% to 32%
LED indicators on Esc and F1 blink simultaneously	33% to 65%
LED indicators on Esc, F1 and F4 blink simultaneously	66% to 100%

How to reset system to factory defaults

For some computer models, you can reset the UEFI BIOS to the factory default settings, including all UEFI BIOS settings and internal system data. It helps you wipe user data in case that you want to dispose of or reuse your computer.

User data erasure is performed on the following components:

- UEFI BIOS
- Security Engine
- Embedded Controller
- Fingerprint Reader
- TPM

1. Restart the computer. When the logo screen is displayed, press F1 to enter the UEFI BIOS menu.
2. Select **Security** → **Reset System to Factory Defaults** and press Enter.
3. Several warning windows might be displayed. Follow the instructions to prepare for the reset.
4. Select **Reset System to Factory Defaults** again and select **Yes** to reset.

Copilot key problems

Follow the instructions to troubleshoot the corresponding Copilot key problems.

Why does Copilot in Windows not open when I press the Copilot key on my keyboard?

It could be caused by the following two reasons.

- Copilot in Windows is available in selected global markets. Maybe your region does not support this function. In such a case, pressing the Copilot key  opens Windows Search.
- Your Windows operating system version is not up to date and does not include the necessary software components.
Update your Windows operating system to version 23H2 or later using Windows Update and then try again.

Self-help resources

Find more information about your device through the following self-help resources.

Product information

- Product specifications: <https://psref.lenovo.com>
- Technical specifications for Lenovo workstations: <https://thinkstation-specs.com>

Lenovo Support resources

- Lenovo PC Technical Support web site: <https://pcsupport.lenovo.com>. You can obtain the following information and resources:
 - Drivers and software
 - Troubleshoot and diagnose
 - How to's
 - Guides and manuals
 - End of service information
 - Warranty lookup
 - Parts lookup
 - Accessories
 - Contact us
 - Repair status check
 - Imaging and security resources
 - Glossary
- Lenovo Support phone numbers: <https://pcsupport.lenovo.com/supportphonenumber>
- Vantage app: Type **vantage** in the Windows search box. You can use the app to:
 - Configure device settings

- Download and install UEFI BIOS, drivers, and firmware updates
- Secure you device from outside threats
- Diagnose hardware problems
- Check the warranty status of your device
- Access *User Guide* and helpful articles
- Lenovo communities:
 - Forums: <https://forums.lenovo.com>
 - Legion Gaming Community: <https://gaming.lenovo.com>
 - Lenovo EDU Community: <https://education.lenovo.com>
 - Lenovo Pro Community: <https://smbcommunity.lenovo.com>
- Troubleshooting tips: <https://www.lenovo.com/tips>

Service information

- Warranty lookup: <https://support.lenovo.com/warranty-lookup>. You can check the warranty status or lookup of your device.
- Repair status check: <https://support.lenovo.com/track-repair-status>. You can check the repair status of your device by repair ticket, serial number, or IMEI number.
- Parts lookup: <https://support.lenovo.com/parts-lookup>. You can find service parts by serial number or machine type.
- Lenovo BIOS Simulation Center: <https://download.lenovo.com/bSCO/index.html>. You can explore the BIOS settings of your device.
- Purchase additional services: <https://pcsupport.lenovo.com/warrantyupgrade>. You can protect your device with extended warranty, Accidental Damage Protection, Premium Care & Support, and Vantage Smart Performance.

Product documentation

Documentation title	Information included	How to Access
<i>Setup Guide</i>	Initial setup and overview information	<ul style="list-style-type: none"> • Access the printed version from the product package • Go to Lenovo PC Technical Support web site https://pcsupport.lenovo.com. Search by the product name or serial number. Click Guides & Manuals.
<i>User Guide</i>	Instructions, guidance, resources, and contact information	<ul style="list-style-type: none"> • Scan the QR code in <i>Setup Guide</i> • In Windows Start menu, click  to open the <i>User Guide</i>. • Type vantage in the Windows search box. Click to open the Vantage app and follow the on-screen instructions to find the <i>User Guide</i>. • Go to Lenovo PC Technical Support web site https://pcsupport.lenovo.com. Search by the product name or serial number. Click Guides & Manuals.
<i>Hardware Maintenance Manual</i>	Hardware diagnostic and replacement information for technicians	Go to Lenovo PC Technical Support web site https://pcsupport.lenovo.com . Search by the product name or serial number. Click Guides & Manuals .

Operating system support resources

- Windows help information.
 - Type **get help** in the Windows search box
 - Use Windows Search or the Cortana® personal assistant
 - Microsoft Support Web site: <https://support.microsoft.com>
- Reset or restore Windows
 - Use Lenovo recovery options: <https://support.lenovo.com/HowToCreateLenovoRecovery>
 - Use Windows recovery options: Go to Lenovo PC Technical Support web site <https://pcsupport.lenovo.com>. Search by the product name or serial number. Navigate to the troubleshooting menu to diagnose the operating system for recovery instructions.

Accessory information

- Purchase accessories: <https://www.lenovo.com/accessories>
- Service recommendation and accessory configurator: <https://smartfind.lenovo.com>
- Accessories and option compatibility matrix: <https://www.lenovo.com/accessoriesguide>

Legal and compliance information

- Product compliance: <https://www.lenovo.com/compliance>
- Legal information: <https://www.lenovo.com/us/en/legal>
- Regulatory documentation: Go to Lenovo PC Technical Support web site <https://pcsupport.lenovo.com>. Search by the product name or serial number. Click **Guides & Manuals**.
 - *Safety and Warranty Guide*: Safety, warranty, recycling, and other information
 - *Generic Safety and Compliance Notices*: Compliance, accessibility, RoHS, and other information
 - *Regulatory Notice*: Regulatory notices for wireless modules

Lenovo responsibility

- Accessibility information: <https://www.lenovo.com/accessibility>
- Environment information: <https://www.lenovo.com/us/en/sustainability-operational-impact>
- Product security: <https://www.lenovo.com/us/en/product-security/landing/>

Call Lenovo

If you have tried to correct the problem yourself and still need help, you can call Lenovo Customer Support Center.

Before you contact Lenovo

Prepare the needed information before you contact Lenovo.

1. Record the problem symptoms and details:
 - What is the problem? Is it continuous or intermittent?
 - Any error message or error code?
 - What operating system are you using? Which version?
 - Which software applications were running at the time of the problem?
 - Can the problem be reproduced? If so, how?

2. Record the system information:

- Product name.
- Machine type and “serial number” on page 70.

Find your service QR code and serial number

This topic helps you find service QR code and serial number.

Scan the QR code on the base cover assembly to view the following information:

- Your product information and warranty status
- The latest Lenovo-verified drivers and software
- Troubleshooting and diagnosing solutions when hardware or software issue is encountered
- Customer support center and e-ticket entry for professional support

You can find your serial number via:

- **Dashboard** or **Device** in the **Vantage** app
- Serial-number label of your computer (shown as below illustration)

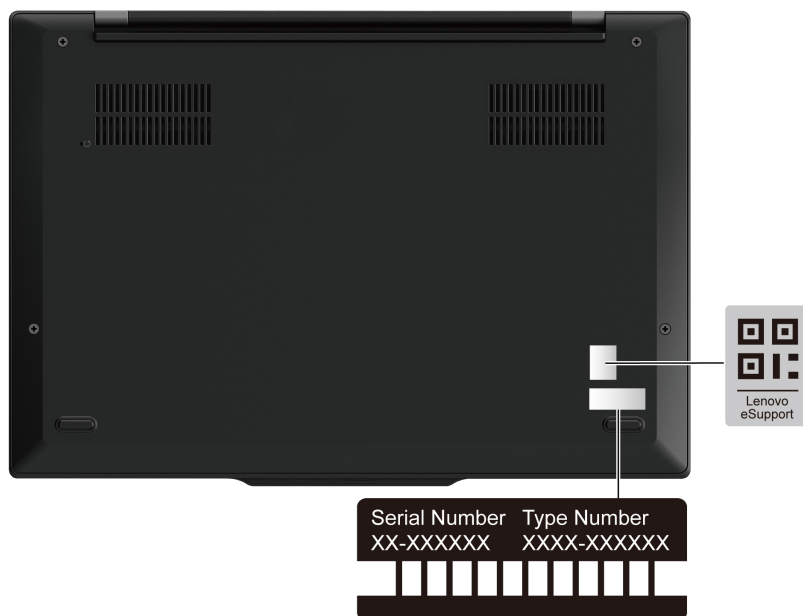

Lenovo Customer Support Center

During the warranty period, you can call Lenovo Customer Support Center for help.

Telephone numbers

For a list of the Lenovo Support phone numbers for your country or region, go to <https://pcsupport.lenovo.com/supportphonenumberlist> for the latest phone numbers.

Note: Phone numbers are subject to change without notice. If the number for your country or region is not provided, contact your Lenovo reseller or Lenovo marketing representative.

Services available during the warranty period

- Problem determination - Trained personnel are available to assist you with determining if you have a hardware problem and deciding what action is necessary to fix the problem.
- Lenovo hardware repair - If the problem is determined to be caused by Lenovo hardware under warranty, trained service personnel are available to provide the applicable level of service.
- Engineering change management - Occasionally, there might be changes that are required after a product has been sold. Lenovo or your reseller, if authorized by Lenovo, will make selected Engineering Changes (ECs) that apply to your hardware available.

Services not covered

- Replacement or use of parts not manufactured for or by Lenovo or nonwarranted parts
- Identification of software problem sources
- Configuration of UEFI BIOS as part of an installation or upgrade
- Changes, modifications, or upgrades to device drivers
- Installation and maintenance of network operating systems (NOS)
- Installation and maintenance of programs

For the terms and conditions of the Lenovo Limited Warranty that apply to your Lenovo hardware product, go to:

- https://www.lenovo.com/warranty/llw_02
- <https://pcsupport.lenovo.com/warrantylookup>

Chapter 7. Diagnose and troubleshoot your computer

This section provides instructions on how to diagnose and trouble shoot your computer.

Error messages

An error message is displayed for each error detected in POST or system operation. Refer to the error messages in the table below to solve your computer problems.

If you see a message that is not included in the following table, record the error message first, then shut down the computer and call Lenovo for help. See “Lenovo Customer Support Center” on page 70.

Message	Solution
0190: Critical low-battery error	The computer turned off because the battery power is low. Connect the ac power adapter to the computer and charge the batteries.
0191: System Security - Invalid remote change requested	The system configuration change has failed. Confirm the operation and try again.
0199: System Security - Security password retry count exceeded.	This message is displayed when you enter a wrong supervisor password more than three times. Confirm the supervisor password and try again.
0271: Check Date and Time settings.	The date or the time is not set in the computer. Enter the UEFI BIOS menu and set the date and time.
210x/211x: Detection/Read error on HDDx/SSDx	The storage drive is not working. Reinstall the storage drive. If the problem still exists, replace the storage drive.

Error: The non-volatile system UEFI variable storage is nearly full.

Note:

This error indicates that the operating system or programs cannot create, modify, or delete data in the non-volatile system UEFI variable storage due to insufficient storage space after POST.

The non-volatile system UEFI variable storage is used by the UEFI BIOS and by the operating system or programs. This error occurs when the operating system or programs store large amounts of data in the variable storage. All data needed for POST, such as UEFI BIOS setup settings, chipset, or platform configuration data, are stored in a separate UEFI variable storage.

Press F1 after the error message is displayed to enter the UEFI BIOS menu. A dialog asks for confirmation to clean up the storage. If you select “Yes”, all data that were created by the operating system or programs will be deleted except global variables defined by the Unified Extensible Firmware Interface Specification. If you select “No”, all data will be kept, but the operating system or programs will not be able to create, modify, or delete data in the storage.

If this error happens at a service center, Lenovo-authorized service personnel will clean up the non-volatile system UEFI variable storage using the preceding solution.

Battery-charge LED indicator diagnosis

The battery-charge LED indicator (hereafter referred to as LED indicator) blinks to help you diagnose and solve some computer problems.

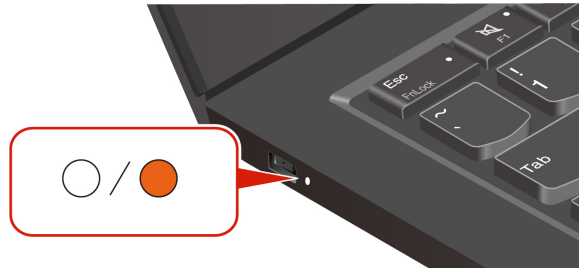

Indicator blinking patterns





The LED indicator blinks amber first and then white continually, consisting of different blinking patterns. Each blinking pattern corresponds to an error code. For example, when the LED indicator blinks amber once ● and then blinks white twice ○○, the blinking pattern ●○○ corresponds to error code 0001.

Notes:

- The LED indicator blinks automatically only when the error in the following table occurs.
- The LED indicator blinks continually until the computer turns off. If you need to interrupt the process, press power button for a few seconds.
- We recommend that you speak to our Customer Support Center before attempting to service the computer yourself so that you can be directed to the correct documentation and repair information. It might be recommended to have a Lenovo-authorized service provider repair your computer depending on the complexity of the error or fault.

Refer to the blinking patterns and error codes in the table below to solve your computer problems.

Blinking patterns	Error codes	Solutions
●○○○	0001: Reset error (platform reset not de-asserted)	<ol style="list-style-type: none"> 1. Remove the ac power adapter and the removable battery if your computer has one. Then, reset the computer by doing one of the following: <ul style="list-style-type: none"> • For models with the emergency-reset hole, insert a straightened paper clip into the emergency reset hole to cut off power supply temporarily. Then, restart the computer with ac power connected. • For models without the emergency-reset hole, press and hold the power button for about seven seconds. Then, reconnect to all power resources and restart the computer. 2. If step 1 does not work, replace the system board (service provider only).
●○○○○	0002: Internal bus error	Replace the system board (service provider only).
●●○○○	0283: PCI resource error	<ol style="list-style-type: none"> 1. Remove PCIe devices (the M.2 card, PCIe card, and so on) (service provider only). 2. If step 1 does not work, replace the system board (service provider only).

Blinking patterns	Error codes	Solutions
	0284: TCG-compliant functionality-related error (might be the BIOS code validation failure)	Replace the system board (service provider only).
	0285: TCG-compliant functionality-related error (might be the TPM initialization failure)	Replace the system board (service provider only).
	0286: Integrated graphics error	Replace the system board (service provider only).
	0288: Computer display error	<ol style="list-style-type: none"> 1. Reconnect the display cable on both the system board side and the computer display side (service provider only) and check the LCD panel. 2. If step 1 does not work, connect an external display to your computer and check the status (customer or service provider). <ul style="list-style-type: none"> • If the external display works, replace the LCD panel (service provider only). • If the external display does not work, replace the system board (service provider only).

Lenovo Memory Self Repair

Lenovo Memory Self Repair (hereafter referred to as repair tool) enables you to repair memory single-bit or single-row failure with internal redundant resources.

It is recommended that you use the repair tool in the following situations:

- The operating system is unstable, such as having blue screen error or system crash.
- Any application operates abnormally, such as crashing or quitting unexpectedly.
- Any test result indicates memory-related errors.

Note: The repair tool can be used only when your computer can be turned on normally.

Step 1. Restart the computer.

Step 2. When the logo screen is displayed, trigger the repair tool by one of the following methods:

- Press F4.
- Press Enter to enter **Startup Interrupt Menu**, and then press F4.
- Press F12 to enter **App Menu**, and then select **Lenovo Memory Self Repair**.

Step 3. Read through the important information in the displayed window and click **Yes** to run the tool.

Step 4. Check the repair result on the pop-up dialog box. There are three types of results.

- **Memory Repaired:** it means that the memory failure is detected and repaired.
- **Memory failure detected but repair was unsuccessful:** it means that the memory failure is detected but cannot be repaired.
- **No failure detected:** it means that no memory failure is detected.

If the issue persists, you can try again or contact Lenovo for additional support.

Step 5. Click **Continue** to turn on the computer.

Related topics

“Call Lenovo” on page 69

Diagnostics tool

This section provides introduction to a set of diagnostics and troubleshooting tools at Lenovo Support Web site, the Vantage app, and in your computer. They can help you diagnose common software and hardware issues.

The following table lists these diagnostics tools and the recommended conditions for each tool.

Diagnostics tool	Recommended scenario
Troubleshoot and diagnose at Lenovo Support Web site	You want to have an online troubleshooting or scan of hardware and drivers on your computer.
Hardware scan	<ul style="list-style-type: none">Your computer is installed with the Vantage app.You want to perform basic examinations of the hardware components.
UEFI Diagnostics tool	<ul style="list-style-type: none">You cannot log in to the operating system.Your computer cannot connect to the network.

Troubleshoot and diagnose at Lenovo Support Web site

Lenovo provides two different diagnosing options to help you identify and resolve problems on your computer.

Step 1. Go to <https://www.pcsupport.lenovo.com/> and enter your product name in the search box.

Step 2. Click **Troubleshoot & Diagnose** and select from the following two options depending on your needs.

If you are unsure of the problem with your computer, it is recommended that you select **Easy** and follow on-screen instructions to get your firmware updated and obtain the hardware status.

If you have identified the problem on your computer, you can select **Custom** and follow on-screen instructions to resolve the problem.

Notes:

- Before launching any automatic diagnosing process, a pop-up window will prompt you to install Lenovo Service Bridge. Lenovo Service Bridge helps to connect your computer with Lenovo diagnosing tools.
- Lenovo Support Web site makes periodic updates of the sections to keep improving your experience with your computer. The Web site interface and descriptions of sections might be different from that on your actual interface.

If solutions cannot resolve problems on your computer, you can follow on-screen instructions to submit an e-ticket or contact Lenovo for professional assistance.

Hardware scan

Hardware scan is an effective hardware testing tool to help you identify existing hardware issues.

To run the Hardware scan:

- Step 1. Type **Vantage** in the Windows search box and then press Enter.
- Step 2. Click **Hardware scan** or **Support → Hardware scan**.
- Step 3. Select **QUICK SCAN** or **CUSTOMIZE** and then follow the on-screen instructions to run the hardware scan.

Notes:

- The Quick Scan tool contains a pre-selected suite of tests that performs basic examinations of the hardware components found in the system. The Customize tool enables you to select one or several hardware components to perform the examinations.
 - Before selecting **QUICK SCAN**, click **Refresh Modules** to ensure that the list of hardware components is the components currently available for the computer.
- Step 4. If any hardware failure is detected, the result varies depending on the warranty status and varies by country or region. Follow the on-screen instructions to resolve the issue.

UEFI Diagnostics tool

UEFI Diagnostics tool enables you to view system information and identify hardware issues when you cannot log in to the operating system, or the computer cannot connect to the network.

To use the UEFI Diagnostics tool:

- Step 1. Connect your computer to ac power.
- Step 2. Turn on your computer, and press F10 immediately to enter the UEFI Diagnostics tool.
- Step 3. Follow the on-screen instructions to run the test.
- Step 4. Press Esc to exit the tool. Your computer will restart immediately.
- Step 5. If any hardware failure is detected and you are unable to locate and resolve the problem, you can call Lenovo Customer Support Center. See “Call Lenovo” on page 69.

Windows label

Windows Genuine Microsoft label indicates the edition of Windows preinstalled on your computer and whether the device is preinstalled with or licensed for genuine Windows.

Your computer might have a Windows Genuine Microsoft label affixed to its cover depending on the following factors:

- Your geographic location
- Edition of Windows that is preinstalled

Go to <https://www.microsoft.com/howtotell/Hardware.aspx> for illustrations of the various types of Genuine Microsoft labels.

- In the People’s Republic of China, the Genuine Microsoft label is required on all computer models preinstalled with any edition of the Windows operating system.
- In other countries and regions, the Genuine Microsoft label is required only on computer models licensed for Windows Pro editions.

The absence of a Genuine Microsoft label does not indicate that the preinstalled Windows version is not genuine. For details on how to tell whether your preinstalled Windows product is genuine, refer to the information provided by Microsoft at <https://www.microsoft.com/howtotell/default.aspx>.

There are no external, visual indicators of the Product ID or Windows version for which the computer is licensed. Instead, the Product ID is recorded in the computer firmware. Whenever a Windows product is installed, the installation program checks the computer firmware for a valid, matching Product ID to complete the activation.

In some cases, an earlier Windows version might be preinstalled under the terms of the Windows Pro edition license downgrade rights.

Chapter 8. CRU replacement

This section provides instructions on how to replace Customer Replaceable Units (CRUs).

Customer Replaceable Units (CRUs) are parts that can be replaced by the customer. The computers contain the following types of CRUs:

- **Self-service CRUs:** Refer to parts that can be replaced easily by customer themselves or by trained service technicians at an additional cost.
- **Optional-service CRUs:** Refer to parts that can be replaced by customers with a greater skill level. Trained service technicians can also provide service to replace the parts under the type of warranty designated for the customer's machine.

If you intend on installing a CRU, Lenovo will ship the CRU to you. CRU information and replacement instructions are shipped with your product and are available from Lenovo at any time upon request. You might be required to return the defective part that is replaced by the CRU. When return is required: (1) return instructions, a prepaid shipping label, and a container will be included with the replacement CRU; and (2) you might be charged for the replacement CRU if Lenovo does not receive the defective CRU within thirty (30) days of your receipt of the replacement CRU. For full details, see the Lenovo Limited Warranty documentation at https://www.lenovo.com/warranty/llw_02.

CRU list

This topic provides the CRU list of your computer.

Self-service CRUs

- ac power adapter*
- Base cover assembly
- M.2 solid-state drive
- M.2 solid-state drive bracket
- Power cord*

Optional-service CRUs

- Built-in battery

* for selected models

Note: Replacement of any parts not listed above should be done by a qualified repair technician or by ensuring that you carefully follow all instructions provided by Lenovo. You can also find Lenovo-authorized repair facilities by going to <https://support.lenovo.com/partnerlocator> for more information.

Before you replace any CRU

Before replacing any CRU, ensure that you disable Fast Startup first and then disable the built-in battery.

Disable Fast Startup

Follow the instructions to disable Fast Startup.

Step 1. Go to **Control Panel** and view by Large icons or Small icons.

- Step 2. Click **Power Options**, and then click **Choose what the power buttons do** on the left pane.
- Step 3. Click **Change settings that are currently unavailable** at the top.
- Step 4. If prompted by User Account Control (UAC), click **Yes**.
- Step 5. Clear the **Turn on fast startup** check box, and then click **Save changes**.

Disable the built-in battery

Follow the instructions to disable the built-in battery.

- Step 1. Restart your computer. When the logo screen is displayed, immediately press F1 to enter the UEFI BIOS menu.
- Step 2. Select **Config → Power**. The **Power** submenu is displayed.
- Step 3. Select **Disable Built-in Battery** and press Enter.
- Step 4. Select **Yes** in the Setup Confirmation window.

The built-in battery is disabled and the computer turns off automatically.

Wait three to five minutes to let the computer cool.

Note: If your computer cannot enter the UEFI BIOS menu, you cannot disable the built-in battery. To ensure safety when you replace a CRU, it is recommended to do the following:

- For the built-in battery connected to the system board with cables: Disconnect the battery cables.
- For the CRUable built-in battery connected to the system board with comb connectors: Remove the battery. For the removal procedure, refer to the built-in battery replacement instructions in this documentation.
- For the non-CRUable built-in battery connected to the system board with comb connectors: Call Lenovo Customer Support Center for help.

To check whether the built-in battery on your computer is a CRU, see the CRU list in Chapter 8 “CRU replacement” on page 79.

Replace a CRU

Follow the instructions to replace a CRU.

Base cover assembly

Follow the instructions to replace the base cover assembly.

Before you start, read [Generic Safety and Compliance Notices](#) and print the following instructions.

Notes: Do not remove the base cover assembly in the following situations. Otherwise, there might be a risk of short circuits.

- When your computer has the removable battery installed
- When your computer is connected to ac power

For access, do the following:

1. Disable the built-in battery. See “Disable the built-in battery” on page 80.
2. Turn off the computer and disconnect the computer from ac power and all connected cables.
3. Close the computer display and turn over the computer.

Tool needed: Phillips head screwdriver

Step 1. Remove the assembly as shown below.

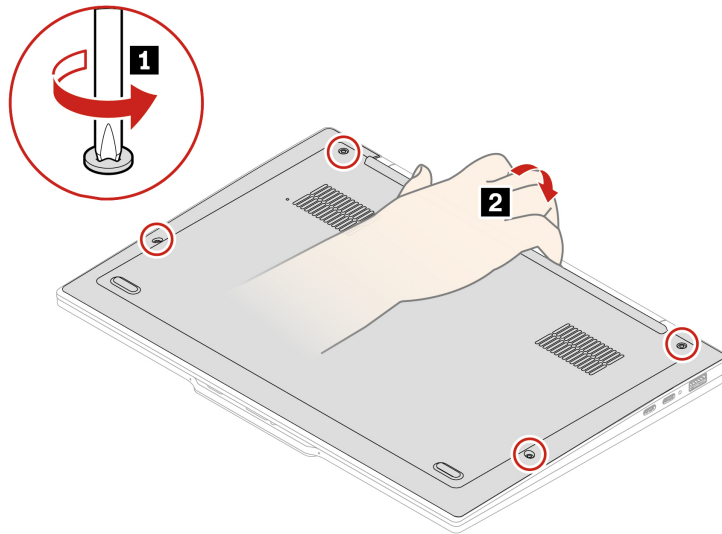

Step 2. Install the assembly in reverse order.

If the computer does not start up after you reinstall the base cover assembly, disconnect the ac power adapter and then reconnect it to the computer.

Built-in battery

Follow the instructions to replace the built-in battery.

Before you start, read [Generic Safety and Compliance Notices](#) and print the following instructions.



Use only the Lenovo-authorized battery specified for the computer. Any other battery could ignite or explode.

Important notices for replacing a battery

Attention: Lenovo has no responsibility for the performance or safety of unauthorized batteries, and provides no warranties for failures or damage arising out of their use.

The Vantage app provides an automatic battery diagnostic test that determines if the built-in battery is defective. A built-in battery should not be replaced unless this diagnostic test shows that the battery is defective. The only exception to this is if the built-in battery is physically damaged or a customer is reporting a possible safety issue.

If the Vantage app is not installed on the computer, the customer should download and install the program to diagnose the built-in battery, before replacing a non-physically damaged built-in battery. Note that the replacement of a physically damaged built-in battery is not covered by the warranty.

For access, do the following:

1. Disable Fast Start up and the built-in battery. See “Before you replace any CRU” on page 79.
2. Turn off the computer and disconnect the computer from ac power and all connected cables.
3. Close the computer display and turn over the computer.
4. Remove the base cover assembly. See “Base cover assembly” on page 80.

Tool needed: Phillips head screwdriver

Step 1. Remove the built-in battery as shown below.

- a. Loosen the six captive screws.

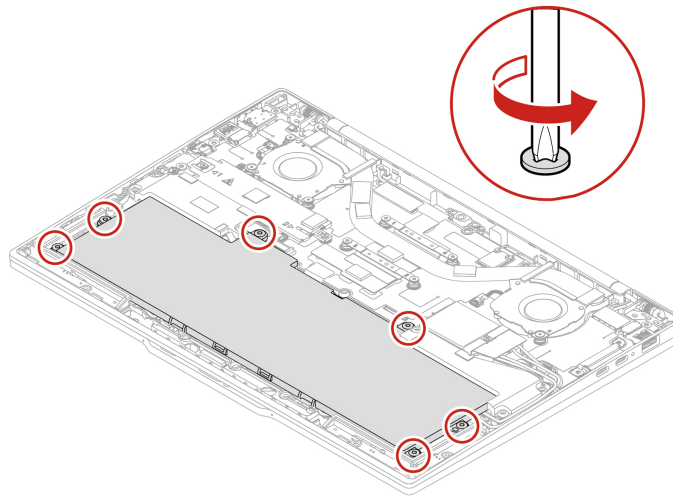

- b. Remove the battery as shown below.

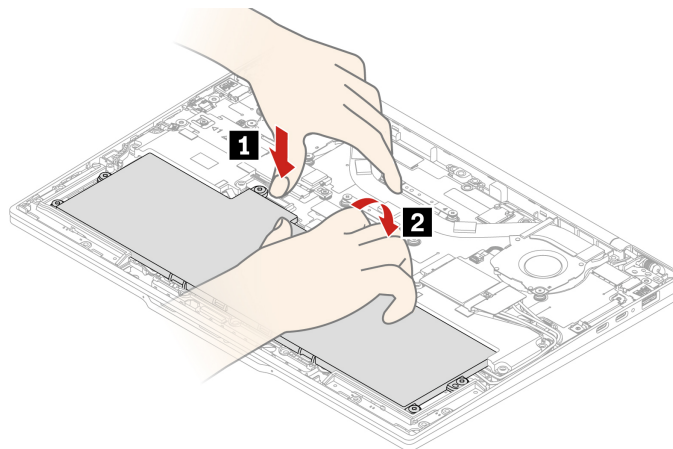

Step 2. Install the built-in battery in reverse order.

CAUTION:

Remove any foreign objects before reassembly.

Ensure that the base cover assembly is secured in place. Otherwise, the battery connection might fail.

M.2 solid-state drive and M.2 solid-state drive bracket

Follow the instructions to replace the M.2 solid-state drive and M.2 solid-state drive bracket.

Before you start, read [Generic Safety and Compliance Notices](#) and print the following instructions.

Attention:

- If you replace a M.2 solid-state drive, you might need to install a new operating system. For details on how to install a new operating system, see “How to install a Windows operating system?” on page 60.

The M.2 solid-state drive is sensitive. Inappropriate handling might cause damage and permanent loss of data.

When handling the M.2 solid-state drive, remove or insert the M.2 solid-state drive horizontally. Otherwise the slot might get damaged.

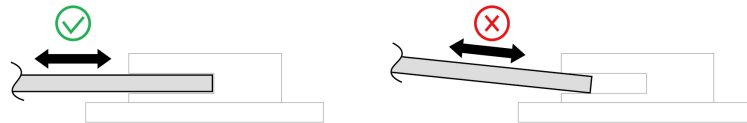

When handling the M.2 solid-state drive, observe the following guidelines:

- Replace the M.2 solid-state drive only for repair. The M.2 solid-state drive is not designed for frequent changes or replacement.
 - Before replacing the M.2 solid-state drive, make a backup copy of all the data that you want to keep.
 - Do not apply pressure to the M.2 solid-state drive.
 - Do not touch the contact edge or circuit board of the M.2 solid-state drive. Otherwise, the M.2 solid-state drive might get damaged.
 - Do not subject the M.2 solid-state drive to physical shocks or vibration. Put the M.2 solid-state drive on a soft material, such as cloth, to absorb physical shocks.
1. Disable the built-in battery. See “Disable the built-in battery” on page 80.
 2. Turn off the computer and disconnect the computer from ac power and all connected cables.
 3. Close the computer display and turn over the computer.
 4. Remove the base cover assembly. See “Base cover assembly” on page 80.

Tool needed: Phillips head screwdriver

Step 1. Remove the M.2 solid-state drive and M.2 solid-state drive bracket as shown below.

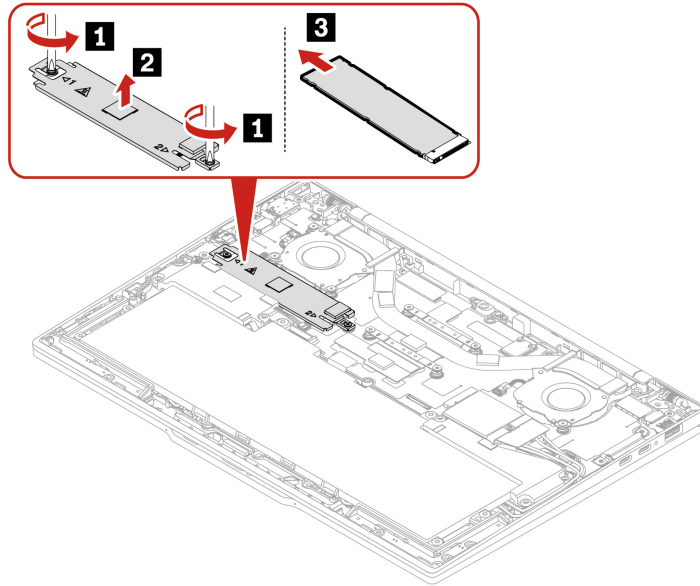

Step 2. Install the M.2 solid-state drive and M.2 solid-state drive bracket in reverse order.

Appendix A. Compliance information

This chapter provides the compliance information of your computer.

For compliance information, refer to *Regulatory Notice* at <https://pcsupport.lenovo.com> and *Generic Safety and Compliance Notices* at https://pcsupport.lenovo.com/docs/generic_notices.

Certification-related information

This section provides certification-related information, such as product name and machine type.

Product name	Compliance ID	Machine type(s)
ThinkPad X1 Carbon Gen 13	TP00150B	21NS and 21NT

Further compliance information related to your product is available at <https://www.lenovo.com/compliance>.

Locate the UltraConnect wireless antennas

Your computer has an UltraConnect™ wireless antenna system. You can enable wireless communication wherever you are.

The following illustration shows the antenna locations on ThinkPad X1 Carbon Gen 13:



- 1 Wireless LAN antenna (main and auxiliary)

Operating environment

This section provides information about the operating environment of your computer.

Maximum altitude (without pressurization)

3048 m (10 000 ft)

Temperature

- Operating: 5°C to 35°C (41°F to 95°F)
- Storage and transportation in original shipping packaging: -20°C to 60°C (-4°F to 140°F)
- Storage without packaging: 5°C to 43°C (41°F to 109°F)

Note: When you charge the battery, its temperature must be no lower than 10°C (50°F).

Relative humidity

- Operating: 8% to 95% at wet-bulb temperature 23°C (73°F)
- Storage and transportation: 5% to 95% at wet-bulb temperature 27°C (81°F)

Appendix B. Notice for USB connector name update

The USB Implementers Forum published a revision of the guideline for USB connector names in September, 2022. Lenovo follows the revised guideline and updates USB connector names accordingly. You can refer to the table below for naming update details.

Current name	Previous name
USB-A connector (Hi-Speed USB)	USB-A 2.0 connector
USB-A connector (USB 5Gbps)	USB-A 3.2 Gen 1 connector
USB-A connector (USB 10Gbps)	USB-A 3.2 Gen 2 connector
USB-A connector (USB 5Gbps, Always On USB)	Always on USB-A 3.2 Gen 1 connector
USB-A connector (USB 10Gbps, Always On USB)	Always on USB-A 3.2 Gen 2 connector
USB-C connector (USB 5Gbps)	USB-C (3.2 Gen 1) connector
USB-C connector (USB 10Gbps)	USB-C (3.2 Gen 2) connector
USB-C connector (USB 20Gbps)	USB 3.2 Gen 2x2
USB-C connector (USB4 20Gbps)	USB 4 Gen 2x2
USB-C connector (USB4 40Gbps)	USB-C (USB 4) connector
USB-C connector (Thunderbolt 3)	USB-C (Thunderbolt 3) connector
USB-C connector (Thunderbolt 4)	USB-C (Thunderbolt 4) connector

Appendix C. Accessibility features

Lenovo is committed to making information technology accessible to everyone, including those with hearing, vision, or mobility limitations. Lenovo supports accessibility features in the following ways to help all users better engage with Lenovo products.

Accessible documentation

Lenovo documentation is designed to meet users' accessibility needs. Users can read the documentation with assistance as needed. For example:

- Text and images are in high contrast. Color contrast can enhance the visual experience. In this mode, all contents are highlighted to be more visible.
- Text is logical and readable. Images are also readable with alternative text provided. A screen reader can enhance the hearing or listening experience. In this mode, all contents are clearer and easier to understand.
- Text is large and clear, making it easier to read. A magnifier can enlarge the text to improve readability.

For more information, watch the video at:

https://support.lenovo.com/docs/pc_pub_accessibility

Accessible product design

Lenovo product design also supports accessibility features.

Note: The accessibility features vary by product. Depending on the product model, some accessibility features listed below might not be applicable to the product. To get the most up-to-date accessibility information for the product, go to <https://www.lenovo.com/accessibility>. For additional support from Lenovo, users can find phone numbers for their country or region from <https://support.lenovo.com/supportphonenumber>.

- **Keyboards**

Lenovo keyboards support various accessibility features. For example:

- Tactile markings on some keys for easier identification

Tactile markings provide all users with a way to find keys without looking at the keyboard. Lenovo provides bumps for the following keys:

- Function keys: F2 and F3
- Control keys: Fn and Insert
- Typing keys: F, J, and Enter
- Navigation key: Down arrow



- Consistent layout of keyboards for easier use
- Appropriate spacing between keys for typing efficiency
- Sufficient contrast of keys, controls, and labels for better visibility
- On-screen notification or lighted notification for some keys for ease of use
- Keys and controls that can be reached and operated using one hand and require minimal dexterity for ease of use

- **Prominent Communication Bar**

As a welcome addition to your computer, the communication bar incorporates front facing camera options and microphone with 360-degree coverage. It helps you orient computer and open laptop easily.

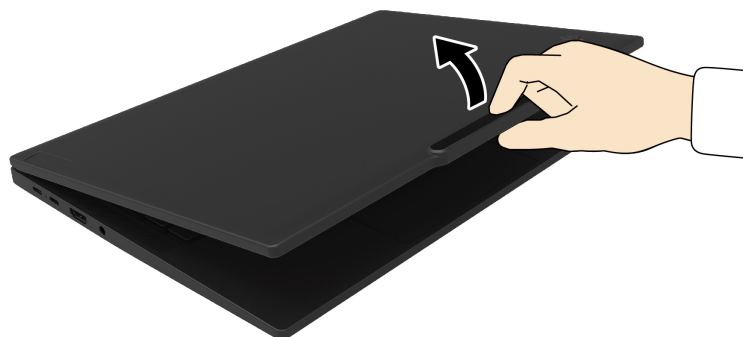

- **Alternative TrackPoint pointing device**

The TrackPoint pointing device comes with TrackPoint pointing stick and TrackPoint Three Buttons. It's a useful alternative for users to interact with the computer without using a traditional mouse. To learn how to use the TrackPoint pointing device, see “Use the TrackPoint pointing device” on page 14

- **Industry-standard connectors**

The industry-standard connectors on Lenovo products enable better compatibility with peripheral devices.

- **Operating systems**

The accessibility features of the operating systems can be configured to assist users in the following ways:

- Vision features, such as text size and visual effect settings, make the screen contents easier to see.
- Hearing features, such as audio and caption settings, make the screen contents easier to hear.
- Interaction features, such as speech and eye-control settings, make the product easier to control.

To access the accessibility features of the Windows 11 operating system, go to **Start → Settings → Accessibility**.

Appendix D. Notices and trademarks

Notices

Lenovo may not offer the products, services, or features discussed in this document in all countries. Consult your local Lenovo representative for information on the products and services currently available in your area. Any reference to a Lenovo product, program, or service is not intended to state or imply that only that Lenovo product, program, or service may be used. Any functionally equivalent product, program, or service that does not infringe any Lenovo intellectual property right may be used instead. However, it is the user's responsibility to evaluate and verify the operation of any other product, program, or service.

Lenovo may have patents or pending patent programs covering subject matter described in this document. The furnishing of this document does not give you any license to these patents. You can send license inquiries, in writing, to:

*Lenovo (United States), Inc.
8001 Development Drive
Morrisville, NC 27560
U.S.A.
Attention: Lenovo Director of Licensing*

LENOVO PROVIDES THIS PUBLICATION "AS IS" WITHOUT WARRANTY OF ANY KIND, EITHER EXPRESS OR IMPLIED, INCLUDING, BUT NOT LIMITED TO, THE IMPLIED WARRANTIES OF NON-INFRINGEMENT, MERCHANTABILITY OR FITNESS FOR A PARTICULAR PURPOSE. Some jurisdictions do not allow disclaimer of express or implied warranties in certain transactions, therefore, this statement may not apply to you.

Changes are made periodically to the information herein; these changes will be incorporated in new editions of the publication. To provide better service, Lenovo reserves the right to improve and/or modify the products and software programs described in the manuals included with your computer, and the content of the manual, at any time without additional notice.

The software interface and function and hardware configuration described in the manuals included with your computer might not match exactly the actual configuration of the computer that you purchase. For the configuration of the product, refer to the related contract (if any) or product packing list, or consult the distributor for the product sales. Lenovo may use or distribute any of the information you supply in any way it believes appropriate without incurring any obligation to you.

The products described in this document are not intended for use in implantation or other life support applications where malfunction may result in injury or death to persons. The information contained in this document does not affect or change Lenovo product specifications or warranties. Nothing in this document shall operate as an express or implied license or indemnity under the intellectual property rights of Lenovo or third parties. All information contained in this document was obtained in specific environments and is presented as an illustration. The result obtained in other operating environments may vary.

Lenovo may use or distribute any of the information you supply in any way it believes appropriate without incurring any obligation to you.

Any references in this publication to non-Lenovo Web sites are provided for convenience only and do not in any manner serve as an endorsement of those Web sites. The materials at those Web sites are not part of the materials for this Lenovo product, and use of those Web sites is at your own risk.

Any performance data contained herein was determined in a controlled environment. Therefore, the result obtained in other operating environments may vary significantly. Some measurements may have been made on development-level systems and there is no guarantee that these measurements will be the same on generally available systems. Furthermore, some measurements may have been estimated through extrapolation. Actual results may vary. Users of this document should verify the applicable data for their specific environment.

This document is copyrighted by Lenovo and is not covered by any open source license, including any Linux® agreement(s) which may accompany software included with this product. Lenovo may update this document at any time without notice.

For the latest information or any questions or comments, contact or visit the Lenovo Web site:

<https://pcsupport.lenovo.com>

Trademarks

Lenovo, Lenovo logo, ThinkPad, ThinkPad logo, and TrackPoint are trademarks of Lenovo. Intel and Thunderbolt are trademarks of Intel Corporation or its subsidiaries in the U.S. and/or other countries. Linux is the registered trademark of Linus Torvalds in the U.S. and other countries. Microsoft, Microsoft Teams, Windows, Windows Hello, BitLocker, , and Cortana are trademarks of the Microsoft group of companies. DisplayPort are trademarks of the Video Electronics Standards Association. Dolby, Dolby Voice, and Dolby Atmos are trademarks of Dolby Laboratories Licensing Corporation. The terms HDMI and HDMI High-Definition Multimedia Interface are trademarks or registered trademarks of HDMI Licensing LLC in the United States and other countries. USB-C® are registered trademarks of USB Implementers Forum. Wi-Fi and Miracast are registered trademarks of Wi-Fi Alliance. All other trademarks are the property of their respective owners.